



This is a digital copy of a book that was preserved for generations on library shelves before it was carefully scanned by Google as part of a project to make the world's books discoverable online.

It has survived long enough for the copyright to expire and the book to enter the public domain. A public domain book is one that was never subject to copyright or whose legal copyright term has expired. Whether a book is in the public domain may vary country to country. Public domain books are our gateways to the past, representing a wealth of history, culture and knowledge that's often difficult to discover.

Marks, notations and other marginalia present in the original volume will appear in this file - a reminder of this book's long journey from the publisher to a library and finally to you.

### **Usage guidelines**

Google is proud to partner with libraries to digitize public domain materials and make them widely accessible. Public domain books belong to the public and we are merely their custodians. Nevertheless, this work is expensive, so in order to keep providing this resource, we have taken steps to prevent abuse by commercial parties, including placing technical restrictions on automated querying.

We also ask that you:

- + *Make non-commercial use of the files* We designed Google Book Search for use by individuals, and we request that you use these files for personal, non-commercial purposes.
- + *Refrain from automated querying* Do not send automated queries of any sort to Google's system: If you are conducting research on machine translation, optical character recognition or other areas where access to a large amount of text is helpful, please contact us. We encourage the use of public domain materials for these purposes and may be able to help.
- + *Maintain attribution* The Google "watermark" you see on each file is essential for informing people about this project and helping them find additional materials through Google Book Search. Please do not remove it.
- + *Keep it legal* Whatever your use, remember that you are responsible for ensuring that what you are doing is legal. Do not assume that just because we believe a book is in the public domain for users in the United States, that the work is also in the public domain for users in other countries. Whether a book is still in copyright varies from country to country, and we can't offer guidance on whether any specific use of any specific book is allowed. Please do not assume that a book's appearance in Google Book Search means it can be used in any manner anywhere in the world. Copyright infringement liability can be quite severe.

### **About Google Book Search**

Google's mission is to organize the world's information and to make it universally accessible and useful. Google Book Search helps readers discover the world's books while helping authors and publishers reach new audiences. You can search through the full text of this book on the web at <http://books.google.com/>

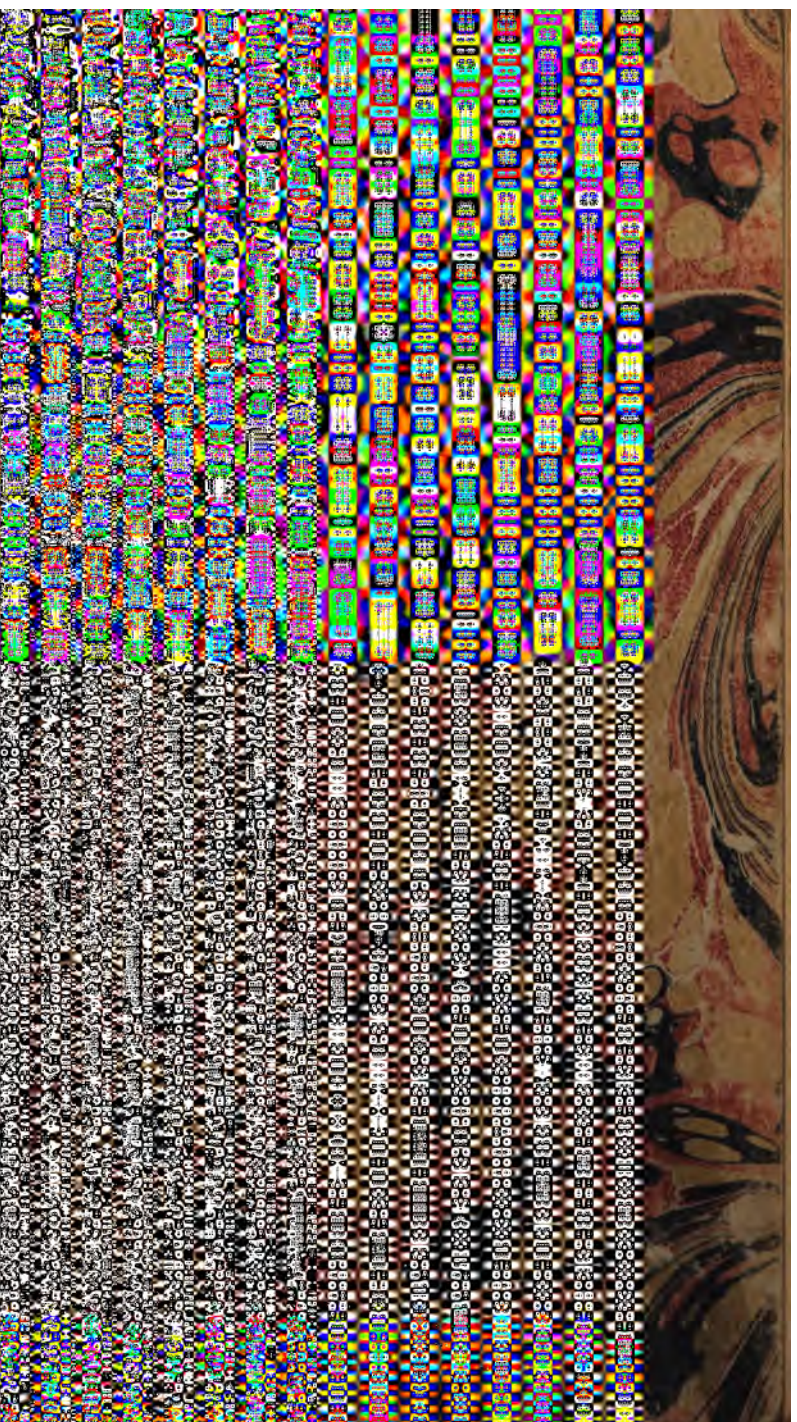

39.

398.



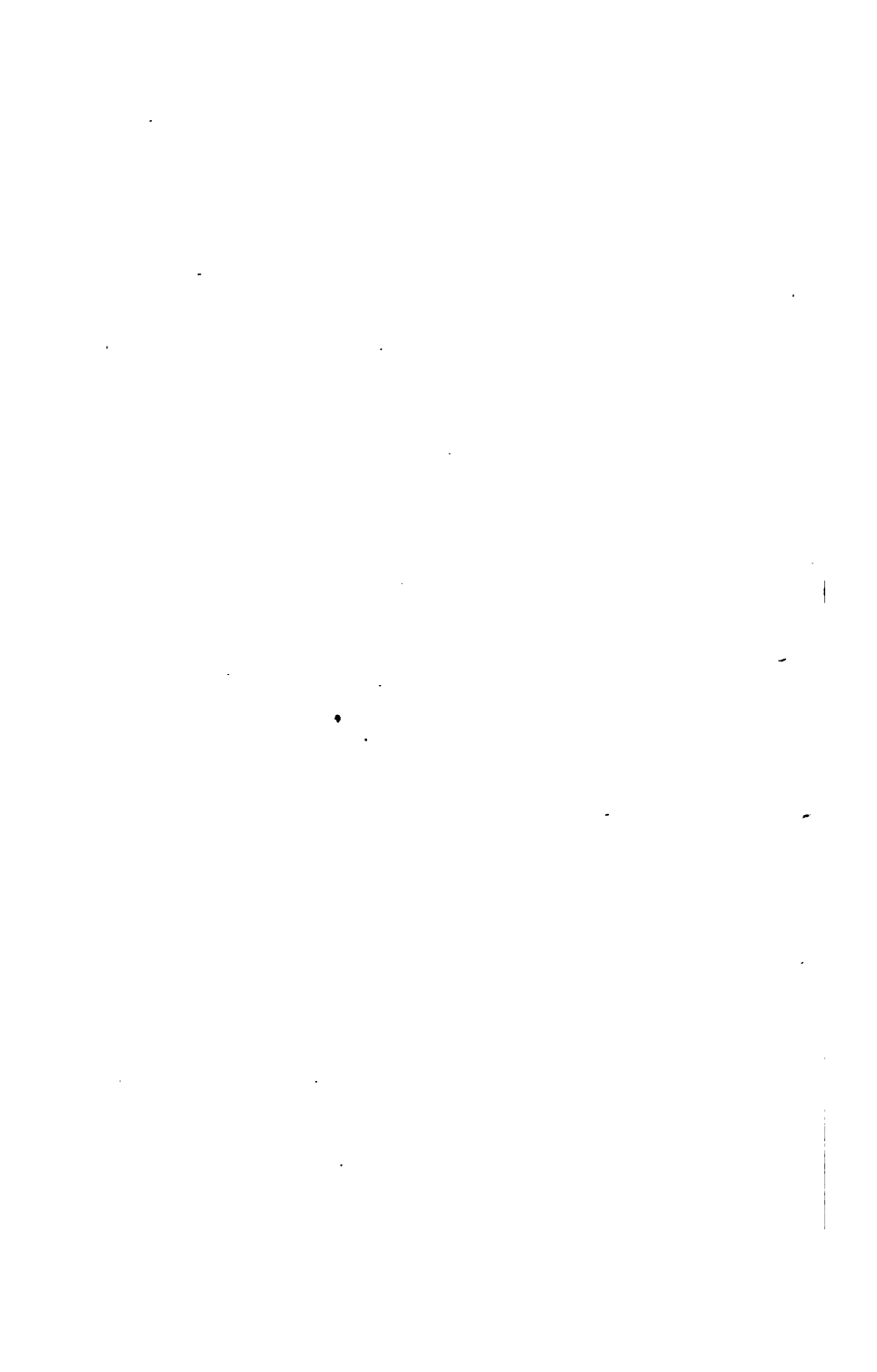

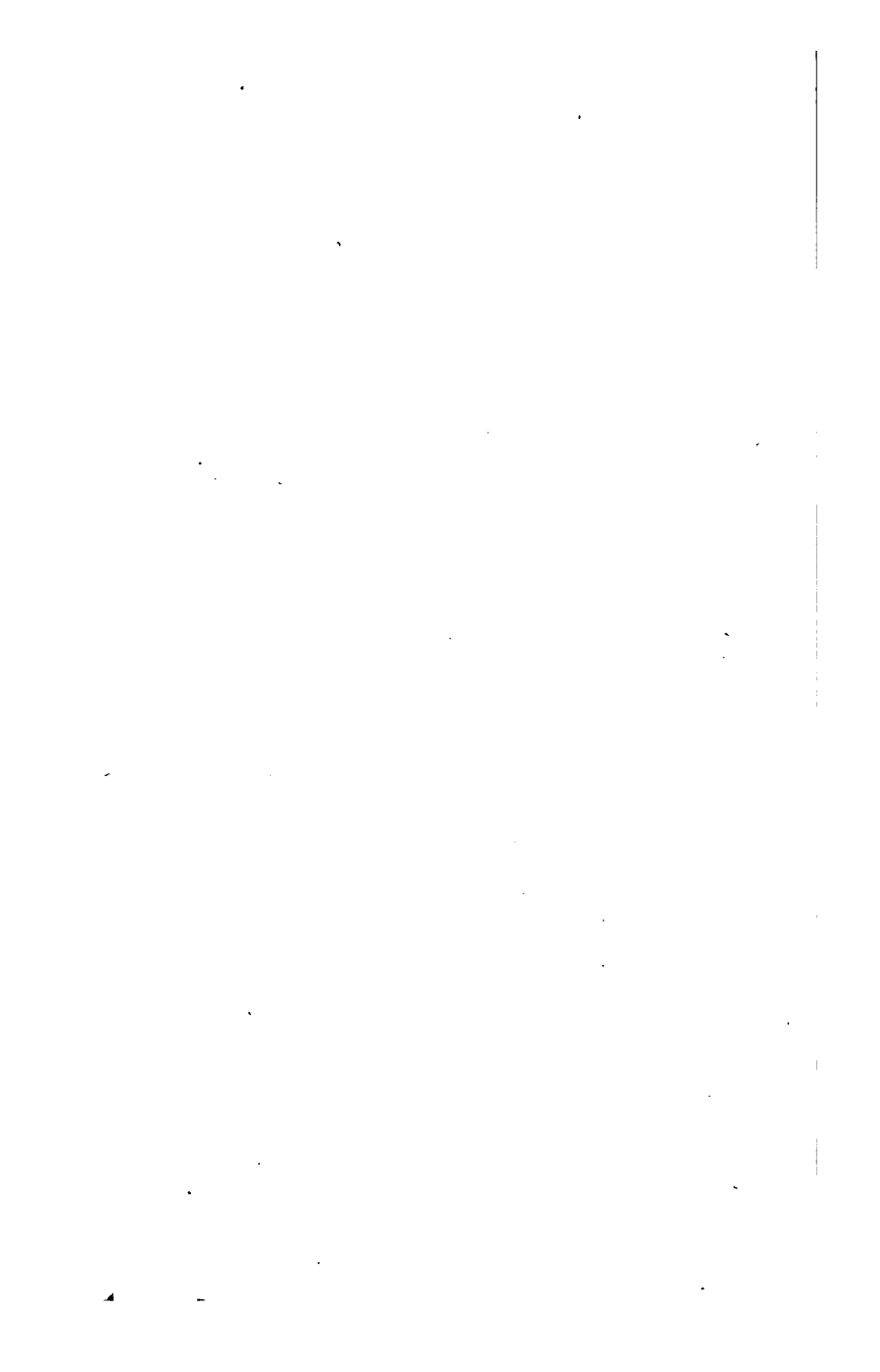

HISTORY AND PRACTICE  
OF  
PHOTOGENIC DRAWING  
ON THE TRUE PRINCIPLES OF THE  
DAGUERRÉOTYPE.

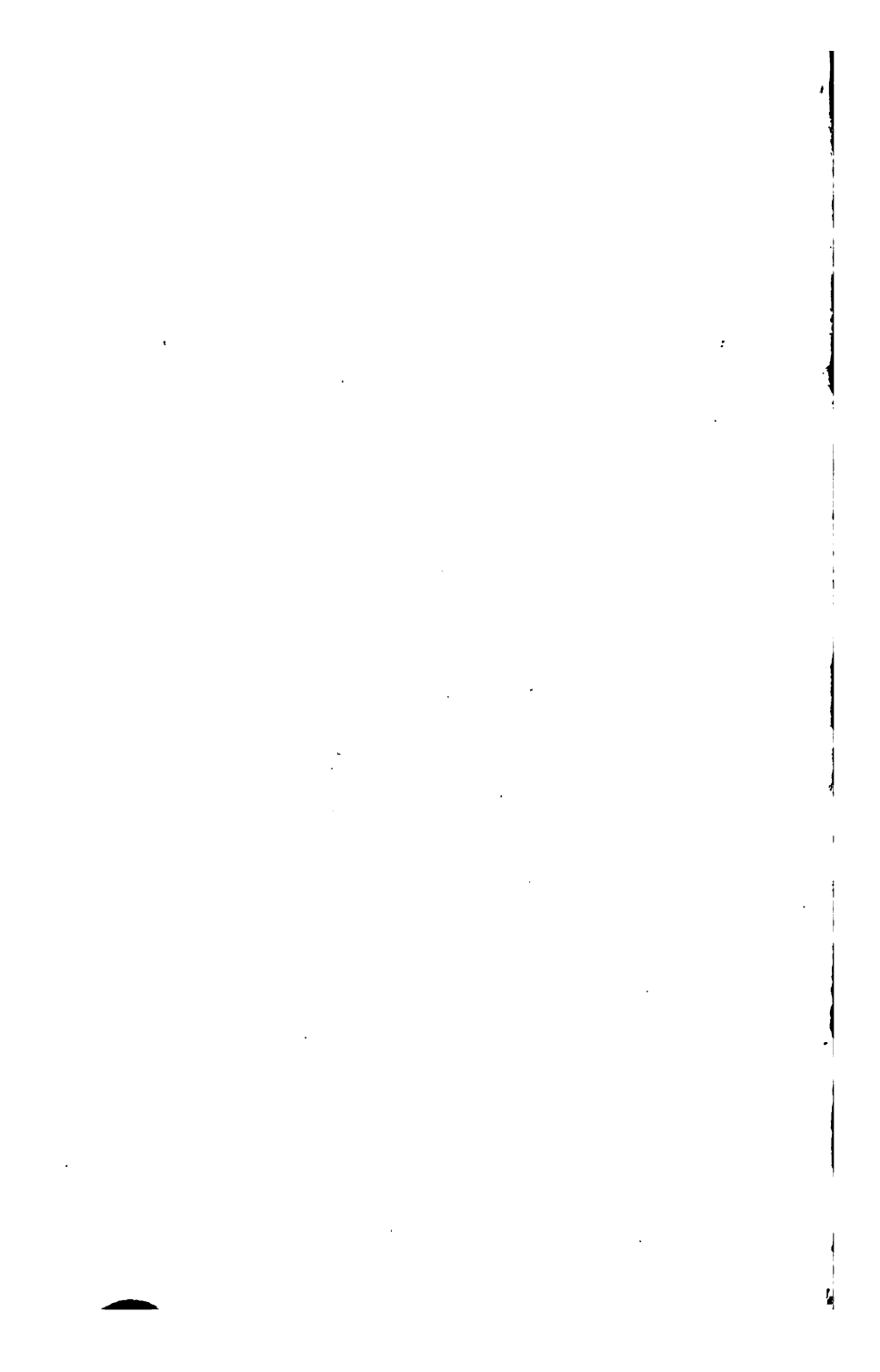

88

88

88

88

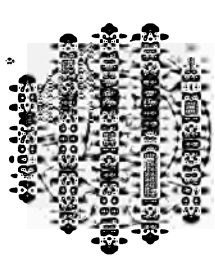

88

88

88

88

88

88

88

88

88

88

88

88



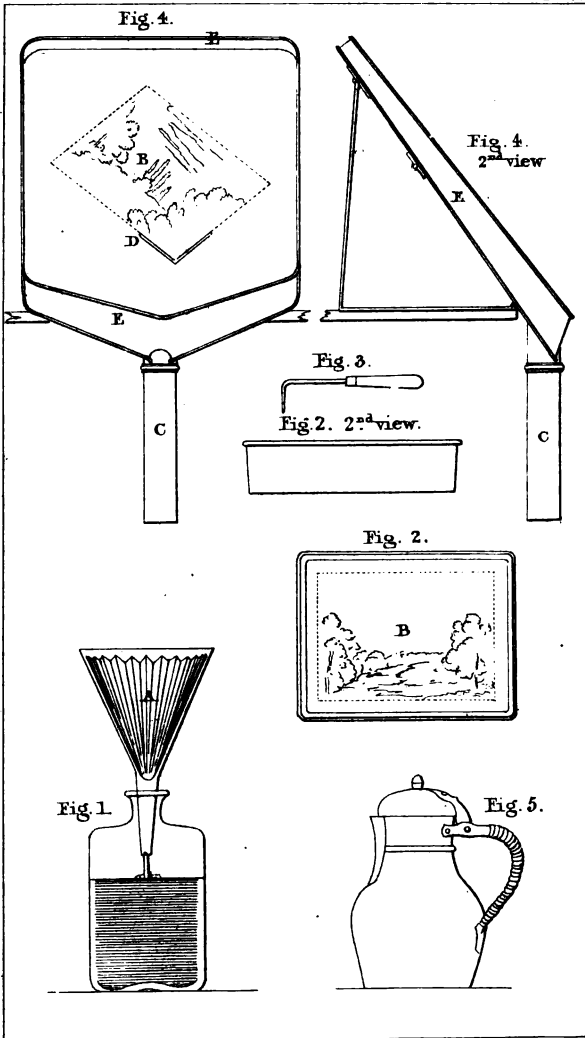

HISTORY AND PRACTICE  
OF  
PHOTOGENIC DRAWING

ON THE TRUE PRINCIPLES OF THE  
DAGUERRÉOTYPE,

WITH THE NEW METHOD OF  
DIORAMIC PAINTING;

SECRETS PURCHASED BY THE FRENCH GOVERNMENT, AND BY THEIR  
COMMAND PUBLISHED FOR THE BENEFIT OF  
THE ARTS AND MANUFACTURES:

BY THE INVENTOR

L. J. M. DAGUERRE,

OFFICER OF THE LEGION OF HONOUR, AND MEMBER OF VARIOUS ACADEMIES.

TRANSLATED FROM THE ORIGINAL BY

J. S. MEMES, LL.D.

HON. MEM. OF THE ROYAL SCOTTISH ACADEMY OF FINE ARTS, ETC.

“As a recompense for giving the secret of this splendid discovery to the world, the French Government has just awarded an Annual Pension of Ten Thousand Francs!”

THIRD EDITION.

LONDON:  
SMITH, ELDER AND CO., CORNHILL;  
AND ADAM BLACK AND CO., EDINBURGH.

1839.

398.



11

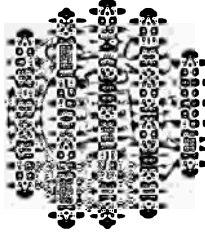

## P R E F A C E.

---

IN presenting this little work to the British public, the translator may perhaps be permitted to observe of his original, that in all its circumstances, it is one of the most interesting works ever given to the world. It is the first Manual of a new science. It is written by the discoverer of that science; exhibiting a faithful record of the progress—the hopes, disappointments, and success of two men, who, in the term of their successive efforts for twenty-five years, laboured incessantly in search of the invention. That invention constitutes an era in human knowledge. It occupies at this moment the attention of every philosopher throughout Europe, and nations have contended for the honour of priority.

The monarch, the government, the people of a great and enlightened state, contending in generous emulation how best to reward this discovery, offers a moral spectacle, noble and spirit-stirring, the rarity of which, alas! in the history of genius, forms another, and not the least striking characteristic of the subject.

The disinterested exertions of the greatest names in the scientific annals of his country—men who occupy the highest places in general estimation—to lift the modest artist into the renown which he merits, and to disclose the real value of his labours, is different evidence of the interest belonging to these pages,—a most pleasing,—and to the glory of science be it said,—not a peculiar association.

Photogenic science, of the practice of which this Manual will render any one master, is to be viewed under two

great relations,—its connexion with science, and its probable influence upon art.

The importance of the fact, that light in its action upon bodies, can be made to pencil, by its own spontaneous and etherial agency, the creations of beautiful nature, cannot be questioned. The science of this new art has indeed not yet been evolved. The principle, we are assured by Arago, is latent among the mysteries yet to be revealed. But no one can peruse the details and operations described in the following pages, without perceiving that by them we gain another step in advance towards that consummation to which modern physics are hastening—namely, the identity of light—electricity—magnetism—gravity. In this sublime walk, the photogenic discoveries have unfolded a “new order of possibilities,” and will aid in leading to one mighty cause, ruling the universe of matter in a dominion, second only to the spontaneity of the Creator.

To the beautiful in art, the invention has yet a nearer relation. It will improve, without materializing its processes. It will give to the artist new subjects of study, in the most difficult department of his profession—the union of grandeur in mass—with exquisite detail; but it arms him with no mechanical contrivance, as has been feared, which may abate the honours of genius.

As an *English* translator, it may perhaps have been expected that I should have said something on the subject of priority, so often urged in my original. The question is one, in the discussion of which it is hardly possible entirely to lay aside preferences and predilections, and time does not permit either the repetition of the experiments or the re-examination of the documents.

J. M.

*London, Sept. 13th, 1839.*

# CONTENTS.

---

## CHAPTER I.

|  | PAGE |
|--|------|
| The Importance of the Photogenic Discovery.—Bill for Rewarding its Authors, proposed by the King of France—Speech of the Minister bringing forward the Motion.—Amount of Rewards granted.—Report of M. Arago to the Chamber of Deputies.—History of Photographic Discovery in England—In France.—Biographical Details.—Utility of the New Invention—to the Arts—to Literature—to Science.—Astronomical Details.—Report of Baron Gay Lussac to the Chamber of Peers.—Principles of Photography.—Its value as national Property to the Arts, Manufactures, and general improvement of a Country. . . . . | 1    |

## CHAPTER II.

|  |    |
|--|----|
| Practical and Historical Details.—Partnership of the two Discoverers.—Account of Niepce's Processes.—His own Notes.—Daguerre's Remarks.—Asphaltum the substance employed for receiving the Impressions of Light—This the old System.—The Solvent.—Its application.—Description of some results.—Additional Notices.—Daguerre's improvements on Niepce's Processes.—Correspondence.—Experiments.—Disappointments.—Daguerre unquestionably prior to Niepce in the application of Iodine. . . . . | 33 |
|--|----|

## CHAPTER III.

|  | PAGE |
|--|------|
| Practical Description of the Daguerrotypé.—Material to be employed in the Photogenic Process.—Five Steps of the Process explained.—Polishing the White Coating with Iodine.—The Camera.—Mercurial Process.—Fixing the impression, with descriptions of the Apparatus. .... | 55   |

## CHAPTER IV.

|   |    |
|---|----|
| Dioramic Painting.—Daguerre's principal Subject.—Selection of the Canvas.—Manner of Painting.—First effect.—Second effect.—Difference between them.—Manner of introducing the Light.—The two effects illuminated by different Lights.—Remarks on Colouring.—Application.—Influence of the Sky on the Colours in Paintings—Effects of this on Artists and Connoisseurs. .... | 69 |
|---|----|

## EXPLANATION OF THE PLATES.

---

N. B. These figures are all drawn to the scale of one French metre, Plate II, which is equal to 39 English inches; operators may thus have the apparatus constructed with very little trouble. The translator would add, from his own experience, that two requisites are indispensable in these experiments: exquisite polish of the plate, and extreme cleanliness in all the operations; dust and stains on the tablet make large blanks in the drawing.

### PLATE I.

Fig. 1 represents the frame of iron wire for the support of the plate, while undergoing the operation of heating. The 1st view is the plane seen from above; the 2nd, is a section and elevation, shewing the manner in which it is fixed. Fig. 6 B is the spirit lamp applied under the plate; A its stopple.

Fig. 2. The plate of plated silver on which the photographic design is made. The dimensions according to the scale are  $8\frac{1}{4}$  inches by 6.4 inches. To operate upon plates of larger dimensions requires all the apparatus to be enlarged, for the same camera which admits light sufficient for such a plate has its intensity too much diminished, when a greater focal distance with the same aperture, and consequently same number of rays, spread over a larger surface. In polishing the plate, begin at C, and strike circularly outwards to the circumference. Vary the direction, however, and invert the process. Always press lightly and evenly. Fig. 2, second view, is the plate seen edgewise: the lines represent (nearly) its thickness. Fig. 4 muslin bag, with pumice powder.

Fig. 3. The little board or wooden tablet upon which the plate is fixed for the succeeding operations after the first one of polishing. It is attached by means of four fillets, B B B B, exactly the same material as the plate itself. To each of these are soldered two small projecting pieces, which embrace the plate near the corners,



and the whole apparatus is retained in position by small nails, or better, screws through holes in the fillets, and inserted by the handle or turn-screw, Fig. 5. The purpose of the fillets is not solely to fix the plate, their more important use is to serve as a kind of frame to it, while undergoing the second process; the application of the iodine: without these, the cooling of iodine would not be equally diffused, for the vapour would condense more rapidly along the edges, and consequently, the coating would be too thin in the centre and too thick round the circumference. It is perhaps not easy to explain so as to satisfy all; but the experimental part is not the less certain. Fig. 3, second view, thickness of the board.

## PLATE II.

Fig. 1. Section of the box for iodine, used in the second operation. The section is supposed to pass down the middle of the apparatus by the line A B, Fig. 2, which represents the same seen from above. C is a small lid, which fits accurately the interior, dividing the whole into two chambers. It is used at all times, except when the operator is actually employed in coating the tablet. Its use is to concentrate the vapour of the iodine, and preserve the whole in a state for equally and rapidly diffusing the vapour, when the plate has been introduced. D is the capsule or little cup in which the iodine is placed. E the small board with the plate attached, face downwards. Four small projecting supports, F receive the four angles and retain the plate in the most favourable position for receiving the vaporization of the iodine as it rises upwards. Of course the cover C is withdrawn. G is the lid of the box, always shut except when the plate is to be withdrawn for examination. H, supports for C. K, tapering sides all round, forming a funnel-shaped box within the other; the funnel-shaped interior diffuses the vapours of iodine, which thus spread as they rise. J, circle of gauze, stretched over a ring, and placed upon the cup with the iodine. The vapour of which rising through this light covering flows up equally, and not in clouds, also the gauze prevents the particles of this substance from flying about, and probably injuring the plate.

Fig. 3. Case for preserving the plates from injury, either before or after they have been impressed with images. They slip into grooves formed in two opposite sides of the case, and at some little distance apart, so that the plates cannot touch in any part of their surfaces. If filled with plates, that have designs, the case should

be wrapped in paper, or better, cloth, to preserve them from dust and light. In travelling, this precaution is always necessary.

### PLATE III.

Plate III. represents four different positions of the frame into which the plate with its wooden tablet is put, on removal from the iodine process. The object of the apparatus is twofold,—to adapt the plate to the camera obscura, and to protect the iodine coating from the action of light till the moment in which it receives the focal image.

A, Half circles which open and shut the doors, B B.

C, Fig. 4. The plate with its wooden tablet fitted into the frame : back view of the *plate* fronting inwards, the door shut upon it.

D, Screws to fix the tablet and plate, and to stop the doors.

E, Thickness of the frame.

F, Fig. 3. Plate : the whole represents the arrangement for receiving the photogenic impressions on the plate, the doors being open, the focal image falls upon the prepared plate, and leaves its impress pencilled there by the rays of light proceeding from the natural objects.

### PLATE IV.

The camera obscura, as adapted to photogenic delineation.

Fig. 1. Perpendicular section lengthways.

A, a ground glass by which the focus is adjusted. It is then removed, and the photographic plate substituted, as in C, Fig. 2. B, a mirror for observing the effect of objects, and selecting points of view. For these purposes it is inclined at an angle of  $45^\circ$ , by means of the support L. To adjust the focus, the mirror is put down altogether, and the ground glass A used. The focus is easily adjusted by means of the sliding frame, as represented in the plate—placing the screws on the double box D, and the projection E : when the focus is adjusted, it is fixed in position by the screw H. The mirror is retained in its place by hooks at F, which catch the eyes at G.

The object glass is achromatic and periscopic. Its diameter is 21 millimetres, and its focal distance 38 centimetres. In English measure  $\frac{21 \times 39}{1000}$  inches, and  $\frac{38 \times 39}{100}$  inches; which can easily be reduced.

This instrument has the disadvantage of reversing the objects. This can indeed be easily obviated by substituting another mirror outside, as K I, Fig. 2. This arrangement, however, injures the effect on the photographic plate from the loss of light. It is therefore not to be employed unless when the operator has time to spare. It increases the time of the operation by one-third of the whole.

#### PLATE V.

Plate V. represents three views of the same apparatus,—that used for the fourth operation ; submitting the plate to the vapour of mercury.

Fig. 1. Section of the apparatus.

Fig. 2. Front view of the same.

Fig. 3. Right side in which the thermometer is placed.

A, Lid of the apparatus.

B, Black board with grooves to receive the small board and plate.

C, Cup containing mercury.

D, Lamp with spirit of wine.

E, Small cock inserted at an angle, through which the mercury is withdrawn after the operation.

F, Thermometer.

G, Glass through which to inspect the operation.

H, Tablet with the plate as removed from the camera.

I, Stand for the spirit lamp which is placed within the ring N, so as to be under the centre of the cup.

All the interior of this apparatus should be black and varnished.

#### PLATE VI.

This plate, fronting the title, represents various apparatus for the last operation of washing the plate.

Fig. 1. Funnel, with plate of paper for purifying the saline wash of salt or hyposulphite of soda.

Fig. 2. Trough of tinned copper, in the bottom of which is represented one of the plates in the act of being washed. Two such troughs must be prepared, one for salt—the other for distilled water.

Fig. 3. Little hook for shaking the plate while in the wash.

Fig. 4. Apparatus in japanned white iron for washing the designs. E, well for receiving the water that flows through the tube C.

Fig. 5. Bottle with wide mouth serving to warm the distilled water and to pour it upon the plate when placed as at B, Fig. 4.

# HISTORY AND DESCRIPTION

OF THE

## DAGUERRÉOTYPE,

&c. &c.

---

### CHAPTER I.

The Importance of the Photogenic Discovery.—Bill for Rewarding its Authors, proposed by the King of France.—Speech of the Minister bringing forward the Motion.—Amount of Rewards granted.—Report of M. Arago to the Chamber of Deputies.—History of Photographic Discovery in England—In France.—Biographical Details.—Utility of the New Invention—to the Arts—to Literature—to Science.—Astronomical Details.—Report of Baron Gay Lussac to the Chamber of Peers—Principles of Photography.—Its value as national Property to the Arts, Manufactures, and general improvement of a Country.

#### BILL FOR REWARDING THE INVENTORS OF THE DAGUERRÉOTYPE.

LOUIS PHILIPPE, KING OF THE FRENCH,

To all present and to come, greeting.

We have ordered and do order, that the Bill preparatory to a law, the tenor of which follows, shall be presented, in our name to the Chamber of Deputies by our Minister the Secretary of State for the Home Department, whom we charge to explain the principles of the Bill and to support them in debate.

*Article First.*—The provisional agreement concluded on the 14th June, 1839, between the Secretary for the Home Department and MM. Daguerre and Niepce, jun. is approved.

*Article Second.*—There is granted to M. Daguerre, an annual pension for life of 6,000\* francs : to M. Niepce, jun. an annual pension for life of 4,000 † francs.

*Article Third.*—These pensions shall be inscribed in the list of civil pensions on the Public Treasury, to be engaged from and after the passing of the present Act. They shall not be subject to any deductions. They shall be one-half in reversion to the widows of MM. Daguerre and Niepce.

Given at the Tuileries this 15th June, 1839.

(Signed) By the King, LOUIS PHILIPPE.

(Signed) Minister Secretary of State, DUCHATEL.

CHAMBER OF DEPUTIES, SECOND SESSION, 1839.

BILL PRESENTED BY THE MINISTER OF THE INTERIOR. ‡

TO THE MEMBERS OF THE CHAMBER.

15th June, 1839.

GENTLEMEN,

WE believe that we only anticipate the wishes of the Chamber in proposing to you to purchase, in name of the State, the right to a discovery as useful as unhopd for, and the publication of which is of vast importance to the arts and sciences.

You all know, and some among you have had opportunities of convincing themselves, that after fifteen years of persevering and expensive researches, M. Daguerre has succeeded in fixing the images obtained in the camera obscura, and thus producing, by the action of light, designs in which the objects preserve their forms with mathematical precision, even

\* 250*l.* sterling.

† 166*l.* 13*s.* 4*d.*

‡ M. Duchâtel.

to the most minute details; in which, also, the effects of linear perspective, and the gradations of tone, depending upon aerial perspective, are brought out with a delicacy hitherto unknown.

We need not insist upon the utility of an invention like this. It is obvious that resources and facilities altogether new, will thus be afforded for the study of the sciences; and as to the arts, the services yet to be rendered, cannot be calculated.

Even the most accomplished draughtsmen and painters, will find subjects of inexhaustible observation and study in these so perfect reproductions of nature. On the other hand, this process will furnish them with a speedy and easy means of forming collections of studies, not otherwise to be obtained, save at the expense of much time and trouble, and yet in a style infinitely less perfect.

The art of engraving, when employed to multiply by reproducing these images, etched by nature herself, will assume a new degree of importance and interest.

In short, for the traveller, the antiquary—as well as for the naturalist—the apparatus of M. Daguerre will come into continual and indispensable use. It will enable them to give permanency to their several thoughts, without having recourse to the hand of a stranger. Henceforth every author will compose the chorographic portion of his own works: by stopping but for a few minutes beside the most complicated monument, or before the most extended landscape, he will instantly obtain a true *fac-simile* of his subject.

Unfortunately for the authors of this beautiful discovery, it is impossible for them to bring their labour into the market, and thus indemnify themselves for the sacrifices incurred by so many attempts, so long fruitless. Their invention does not admit of being secured by patent. So soon as it becomes known, every one may avail himself of its advantages. The most unskilful will produce designs, with the same exact-

ness, as the most accomplished artist. Of necessity, then, this process must belong to all; or remain unknown. How just would be the regrets expressed by every friend of art and science if such a secret were left impenetrable to the public,—if it were to perish and die with its discoverers ?

In circumstances like these, it is the duty of the State to come forward. Government ought to put society in possession of an invention which its general interests demand should be known, provided the price, or rather reward of the discovery be secured to its authors.

Such are the motives that have induced us to conclude with Messrs. Daguerre and Niepce, a provisional arrangement, as explained in the Bill, which we have now the honour to submit for your sanction. But before we can explain the basis of this agreement, some details are necessary.

The possibility of arresting for a space the images of the Camera has been known since the last century; but this discovery produced no result of utility, because the substance upon which the solar rays painted these images, did not possess the property of preserving them, turning it completely black when exposed to the day-light.

M. Niepce, sen., discovered a method of rendering these images permanent; but, though he resolved this difficult problem, his invention, nevertheless, remained very imperfect. He obtained only a silhouette, or black profile of objects, and twelve hours, at least, were required to produce even the smallest design.

It was by following out views entirely different, putting aside altogether the processes of M. Niepce, that M. Daguerre arrived at those admirable results which we now behold,—namely, extreme promptitude of operation, and reproduction of the aerial perspective, with all the play of light and shadow. The method of M. Daguerre is his own; it belongs exclusively to him, and is distinguished from that

of his predecessor, both in its cause and by its effects. At the same time, as there had passed between M. Daguerre and the late M. Niepce, certain agreements, mutually to divide whatever advantages might accrue from their discoveries; and as this stipulation had been continued, with M. Niepce, jun., on the death of his father, it would be impossible to treat now with M. Daguerre alone, even concerning a process which he has not merely brought to perfection, but which he invented.

It must not be forgotten, besides, that the method of M. Niepce, even although it has continued imperfect, may perhaps be susceptible of receiving some improvements, of being usefully applied in certain circumstances, and, consequently, for the history of science it is important that it be published along with M. Daguerre's system of photographic delineation.

These explanations, gentlemen, will enable you to comprehend from what cause, and under what relations Messrs. Daguerre and Niepce come before you as parties interested in the bill to be brought before the house.

A sum of 200,000 francs\* was at first asked of us as the price of the inventions of MM. Niepce and Daguerre; and it ought to be stated that offers coming from foreign sovereigns justified this demand. We have, however, arranged that in place of the capital stipulated, a life interest shall be granted, namely, a pension of 10,000 francs,† with only the half in reversion to the widows. The assignment of this pension to be as follows:—

|                      |             |
|----------------------|-------------|
| To M. Daguerre . . . | 6000 francs |
| To M. Niepce . . .   | 4000 francs |

Independent of the considerations mentioned above, there is one circumstance, which of itself justifies this division. M. Daguerre has consented to give up for publication the pictorial

\* Nearly eight thousand guineas.

† 41*l.* 13*s.* 4*d.*



and philosophical processes by which he produces the effects of Dioramic art, an invention of which he alone possesses the secret, and one most desirable to be known.

Before signing the agreement, M. Daguerre placed in our hands, under seal, the description of M. Niepce's process, an account of his own, and lastly the secret of the Diorama.

We can assure the Chamber that these descriptions are complete and faithful; for a member of this assembly, whose name is incontestible authority,\* who received from M. Daguerre the confidential communication of all his processes, and who has himself tested them, has had the kindness to examine these papers and to guarantee their accuracy.

We hope, gentlemen, that you will approve both the motive which has dictated these arrangements, and the conditions upon which they have been concluded. You will concur in a sentiment which has already awakened universal sympathy, you will never suffer us to leave to foreign nations the glory of endowing the world of science and of art with one of the most wonderful discoveries that honour our native land.

---

CHAMBER OF DEPUTIES, SECOND SESSION, 1839.

REPORT made in name of the Commission charged with the examination of the Bill proposing to grant—1st, to M. Daguerre an annual pension for life of 6000 francs (250*l.*); 2nd, to M. Niepce, jun. an annual pension of 4000 francs (166*l.* 13*s.* 4*d.*), for the renouncement made by them of a process for fixing the images of the Camera Obscura.†

\* M. Arago.

† This commission was composed of the following members of the Chamber :—MM. Arago, Etienne, Carl, Vatout, de Beaumont, Tournouër Delessert (François), Combarel de Leyval, and Vitet, all names distinguished in science.

By M. Arago, Deputy for the Eastern Pyrenees, presented to the Chamber at its Sitting 3rd July, 1839.

GENTLEMEN,

THE interest manifested both within these walls and throughout Europe in those labours, the result of which M. Daguerre recently submitted to the public, has been lively, striking, and unanimous. The Chamber, therefore, in all probability expects of its commission only a simple and entire approbation of the Bill presented on this subject by the Minister for the Home Department. After mature reflection, however, it appeared to us that the office with which you had invested us imposed other duties. We have deemed that while applauding the happy idea of instituting national recompenses in favour of those inventors whose interests the ordinary legislation by patent could not protect, it was requisite, in the very first steps of this new career, to shew with what reserve, with what hesitation the Chamber would proceed. To subject to a minute and rigid examination the work of genius upon which we are this day called to legislate, will be to discourage ambitious mediocrity; for minds of this character also would otherwise aspire to intrude on your notice their ordinary and inconsequent attempts; it will prove that you intend to place in a most elevated region the recompenses which shall be demanded of you in the name of national glory,—that you will never consent to bring them down from this elevation,—or by lavishing them to tarnish their splendour.

These few remarks will enable the House to understand why we have been led to examine,—

If the process of M. Daguerre be incontestibly an invention,—

If this invention will render to archeology and the fine arts services of value,—

If it can become generally applicable,—

And finally, if we may hope that by it the sciences will be benefited.

Two centuries ago, a philosopher of Naples, Giovanni Battista Porta, discovered that if a very small hole be pierced in the window-shutter of a room completely darkened in other respects; or better still, if the aperture be perforated in a thin metallic plate applied to the shutter; all the exterior objects from which rays can enter through this opening will be represented on the opposite wall; in dimensions enlarged or diminished according to the distance. He found also that even with this imperfect apparatus, throughout a large extent of the picture, objects were painted in their natural colours, and with considerable truth of linear perspective. A short time afterwards Porta found that it was not necessary to have the opening very small, thus limiting the view, but that if the perforation were covered with a lentiscus or convex glass, it might be of any dimension. He remarked also the great improvement thus produced in the delineation. The images passing through the simple medium of the hole were without distinctness of position, intensity of colour, or neatness of outline. On the contrary, with the lentiscus, the mimic forms rivalled the vivacity and strength of nature herself, the focal distances being properly adjusted. It is well known that all these discoveries of Porta have become truly astonishing in precision of detail and strength of colouring since the art of constructing achromatic glasses has been brought to its present perfection. Formerly a simple lentiscus composed of one kind of glass only, and consequently acting with as many separate focuses as there are colours in the undecomposed white ray, transmitted a comparatively indistinct image of objects. Now that we employ achromatic glasses which combine all the incident rays in one focus, and that a periscopic construction of the apparatus likewise has been adopted, great perfection has been given of its effects.

Porta constructed also portable dark chambers; these were composed of a tube, longer or shorter, armed with a

lenticulus as its optic instrument. A screen of white paper, or some prepared substance, occupied the focus, and upon it the images of external objects were received. The Neapolitan philosopher proposed his simple arrangements for the benefit of those who had not been taught drawing. According to him, nothing else was required in order to obtain the most perfect transcripts of nature than merely to trace carefully the outline of the focal image.

These anticipations of Porta have not been completely realized. Painters and draughtsmen, those particularly who execute large views for panoramas, dioramas, and theatres, have indeed still recourse to the camera. They, however, employ it merely to groupe objects *en masse*, to trace their contours, and to fix them in their proper position and magnitude, according to the principles of linear perspective. As to those effects proceeding from the imperfect transparency of our atmosphere, whence arise all the charms of tone and colouring, which by a sufficiently erroneous appellation are designated by the term *aërial perspective*,—the most experienced artists are aware that in reproducing these the camera affords them no assistance.\* No person, however, has ever witnessed the neatness of outline, precision of form, the truth of colouring, and the sweet gradations of tint, without regretting that an imagery so exquisite and so faithful to nature could not be made to fix itself permanently on the tablet of the machine—who has not put up his aspiration that some means might be discovered by which to give reality to shadows so exquisitely lovely? Yet, in the estimation of all, such a wish seemed destined to take its

\* This is not altogether correct: although the camera can by no direct application give permanently the *aërial perspective*, it is well known that for the gradation of colour—the comparative strength of near and distant lines—few studies are more advantageous to the artist than to view his object in a camera, and paint from its representations. This perhaps is all that M. Arago meant to be implied.—TRANSLATOR.

place among other dreams of beautiful things,—among the glorious but impractical conceptions in which men of science and ardent temperament have sometimes indulged. This dream, notwithstanding, has just been realized. Let us take, then, the invention in its germ, and mark carefully its gradual unfolding.

Long ago the Alchemists had succeeded in forming a solution of silver in muriatic acid. This compound, which assumes the appearance of a white salt, they called *lunar* or *caustic silver*.\* This salt possessed the remarkable property of becoming black by light, and of blackening more or less rapidly in proportion to the intensity of the incident rays. Cover a sheet of paper with a wash of lunar caustic, or, as we say at present, with a wash of chloride of silver; form upon this by means of a lens the image of an object; the shaded parts of the image—the parts, that is to say, upon which no light falls—will remain white; the portions, on the other hand, strongly illuminated, will become completely black; the demi-tints will be represented by grays more or less dark. This monochrome, in short, will be the reverse of the real object as respects the lights and shadows.

Again, if an engraving be placed upon a sheet of paper moistened with a solution of chloride of silver, and both be exposed to the solar light, the engraving being uppermost, the dark lines of the latter will intercept the rays, and the corresponding portions of the paper below will retain their original colour. In those parts, on the contrary, which lie immediately under the lights in the engraving, the solar rays, acting through the imperfect transparency of the print, will blacken the chloride wash. The necessary consequence

\* In the work of Fabricius (*De Rebus Metallicis*), printed in 1568, there occurs a lengthened account of a kind of mineral called Horn Silver, having the colour and transparency of the artificial substance with the fusibility and softness of wax. This mineral, exposed to the light, passed from *yellowish grey* to *violet*, and by prolonging the action, *almost to black*. This substance was nothing more than *Natural Lunar Caustic*.

of this operation will be a copy of the engraving, correct in its outlines, but reversed in its effects, the lights being reproduced in shadows and the shadows in lights.

These applications of this curious property of the chloride of silver, one would think, might have readily occurred to the Alchemists, the first discoverers of the substance, or to their early successors, who devoted more attention to practical results. Not so, however, was the case. We must descend to the first years of the 19th century before we detect even the beginnings of the photographic art.

About this time our countryman Charles, in his lectures, made use of a prepared paper to produce silhouettes, or black profiles, by the action of light. Charles died without describing the preparation which he employed. As the historian of science, under pain of falling into inextricable confusion, is not authorised to proceed, except upon printed and authentic documents, it is no more than justice to assign to Wedgewood, the celebrated porcelain manufacturer and inventor of the pyrometer for high temperatures, the first application of this new art.

The memoir of Wedgewood appeared in 1802 in the number for June of the Journal of the Royal Institution of Great Britain. The author there proposes by means of skins, or with paper steeped or washed in chloride or nitrate of silver, to copy paintings on glass as in the windows of churches, and also engravings. "The images formed by means of the camera obscura," we quote faithfully a passage from the article, "have been found to be too faint to produce, in any moderate time, an effect upon the nitrate of silver."

The commentator upon Wedgewood's experiments, the illustrious Davy, does not contradict the assertion relative to the images of the camera. He merely adds, as to his own experiments, that he has accomplished the copying of very small objects by the solar microscope, but only *at a short distance from the lens*.

Finally, neither Wedgewood nor Sir H. Davy discovered how,

the operation once finished, we were to give it permanence, or, if I may be permitted the expression,—to remove from the canvas of their pictures the defect of becoming black by the light. It thence resulted that the copies which they had obtained could not be examined in day-light, for in a very short time they became uniformly black, and all lineaments of the previous objects disappeared. What was this in reality but to produce imagery so evanescent that only a furtive glance could be cast upon the work, and that by the light of a lamp? The whole would have vanished in a few seconds if these delineations had been examined in day-light.

After these imperfect, these unimportant essays, of which we have just given an analysis, we arrive at the researches of Messrs. Niepce and Daguerre, without encountering in our course any intermediate experimenters of any country.

The late M. Niepce was a country gentleman, who lived on his property near Châlons, on the Saône. He devoted the leisure of a studious and retired life to the pursuits of science. One of his discoveries in reference to a contrivance for substituting heated atmospheric air in place of steam in machinery, underwent, with considerable success, a very rigorous trial,—an examination before the Academy of Sciences. The *Photographic* researches\* of M. Niepce appear to have been begun so early as the year 1814. His first connexion with M. Daguerre dates from the month of January 1826. The indiscreet revelations of an optician at Paris disclosed to him the experiments of Daguerre, then also engaged in researches whose object was to fix by some chemical or other process the images obtained with the camera. These facts are authenticated by letters which have been submitted to our perusal.† In the event then of dispute or previous claim, the first

\* Or Photogenic, according to the more popular expression in this country. I have used the former, because throughout my original, except in one instance, it is exclusively employed. Either is equally correct, signifying delineated or formed by light.—TRANSLATOR.

† These letters are inserted in Chapter II.

photographic labours of Daguerre can thus be determined with unquestionable certainty to have attained some shape in the year 1826.

In the following year M. Niepce repaired to England. In the month of December 1827, he presented a paper on his photographic experiments to the Royal Society of London. This memoir was accompanied with several sketches on metal produced by methods then already discovered by our countryman. On an attempt having been made to establish a priority of invention, these sketches, still in a state of good preservation, were immediately and honourably produced from the collections of certain English philosophers. They prove beyond dispute, as respects both the photographic copies of engravings, and the formation, for the use of artists, of plates in the state of advanced etchings, that M. Niepce in 1827 was acquainted with a method of making the shadows correspond to shadows, the demi-tints to the demi-tints, the lights to the lights. These early essays farther prove that he had discovered how to render his copies, once formed, impervious to the erasing and blackening effects of the solar rays. In other words, the ingenious experimentalist of Châlons, by the composition of his grounds, had so early as 1827 resolved a problem, which had defied the lofty sagacity of a Wedgwood and a Davy.

The deed of co-partnery between Messrs. Niepce and Daguerre, for mutually investigating and following out the subject of photography, is fortunately registered among the public records, and bears date Dec. 16, 1829. Later deeds entered into by M. Isidore Niepce, as his father's heir, and M. Daguerre, distinctly mention, in the first place, the improvements made upon the earlier methods of the philosopher of Châlons, by the Parisian artist:\* in the second instance, they also particularize processes entirely new, invented by M. Daguerre, and possessing the advantage (in terms of the deed) "of producing images with sixty or

\* See Note (1) at the end.



eighty times greater rapidity than the earlier applications of the photographic principle."

In what we have just observed, regarding the studies of M. Niepce, these restrictive expressions have doubtless been remarked—"for the photographic copy of engravings." It was only, in truth, after a multitude of fruitless attempts, that M. Niepce himself had almost renounced the idea of ever being able to fix the image in the camera. The difficulties which presented themselves in the course of his investigations were chiefly the following. The preparations which he at first employed as the ground of the future design, did not yield with sufficient rapidity to the action of the solar rays, so that ten or twelve hours proved hardly sufficient for producing a single design. During an interval so protracted, the shadows cast upon the various points of view were very much altered, indeed, entirely changed in place, form, and extent: they had passed, in fact, from the left to the right of objects, and this traverse, wherever it operated, gave birth to flat and uniform tints, without life or distinctness. In the results of a method so imperfect, all the effects arising from the contrasts of light and shadow were lost. Again, amid these manifold inconveniences, the operator was by no means sure of succeeding; after infinite precautions, causes unassignable or fortuitous, gave him sometimes a tolerable result; at others, he obtained only an incomplete image, with here and there extensive blanks. In fine, when exposed to the solar rays, the grounds, upon which the images were impressed, if they did not become black, cracked and came off in small scales. By taking the opposite of each of these defects, an enumeration nearly complete will be obtained of the merits of the method discovered by M. Daguerre, after an immense number of minute, difficult, and expensive experiments.

The feeblest rays impress the substance of the Daguerreotype. The effect is produced before the shadows have had time to change in any appreciable degree. The results are

certain, by the operator's acting according to a few very simple directions. Finally, the images being once produced, the solar rays continued for years, affect neither their purity, brightness, nor harmony.

Your commission have made the necessary dispositions for enabling all the members of the Chamber, during the day appointed for the discussion of the Bill, if they judge it proper, to verify the results of the Daguerriotype, and to form for themselves an opinion on the probable utility of such an apparatus. Upon examining several of the pictures to be submitted for your inspection—all will consider the immense advantages which would have been derived, during the expedition to Egypt for example, of a means of reproduction so exact and so rapid: all will be struck with this reflection, that if photography had been known in 1798, we should this day have possessed faithful representations of many valuable antiquities now, through the cupidity of the Arabs, and the vandalism of certain travellers, lost for ever to the learned world.

To copy the millions and millions of hieroglyphics which entirely cover to the very exterior the great monuments at Thebes, Memphis, Carnac, &c. would require scores of years, and legions of artists. With the Daguerriotype,\* a single man would suffice to bring to a happy conclusion this vast labour. Arm the Egyptian Institut with two or three of Daguerre's instruments, and on several of the large engravings in that celebrated work, the fruit of our immortal expedition, vast assemblages of real hieroglyphics would replace fictitious or purely conventional characters. At the same time these designs shall incomparably surpass in fidelity, in truth of

\* This is the name given to the apparatus fitted up on the principles of M. Daguerre's system of photographic or photogenic painting. All scientific terms ought to express either a *fact* or a *name*. The French generally prefer the latter, English philosophers the former element of nomenclature.—TRANSLATOR.

local colour,\* the works of the ablest artists. Again, these photographic delineations having been subjected, during their formation, to the rules of geometry, shall enable us, with the aid of a few simple data, to ascertain the exact dimensions of the most elevated parts, and of the most inaccessible edifices.

These reminiscences, in which, if I am not strangely mistaken, neither the philosophers nor the artists, so zealous and so celebrated, who were attached to the army of the East, can detect the shadow of blame, will doubtless recall the thoughts to those labours now carrying on in our own land, under the superintendence of the Commission of Ancient Monuments. At a glance, each of you, Gentlemen, will perceive the important part which these photographic processes are destined hereafter to assume in this great national enterprise. Each will comprehend, also, that the new method will be distinguished by economy,—a species of merit, be it observed, rarely combined in the arts with perfection of result.

If, finally, it be asked, can art viewed in its own interests be expected to derive advancement from the examination, from the study of those forms designed by the most subtile, the most refined agency in nature—the rays of light?—M. Paul Delaroche shall reply to the question.

In a letter written at our request, this celebrated painter declares that the processes of M. Daguerre “carry to such perfection certain of the essential principles of art, that they must become subjects of study and observation, even to most accomplished artists.” What strikes him in the photographic designs is, that the finish “of inconceivable minuteness disturbs, in no respect, the repose of the masses, nor impairs, in any manner, the general effect.” “The correctness of the lines,” remarks M. Delaroche, in another place,

\* I confess myself at a loss exactly to comprehend what M. Arago here means by the expression *couleur locale*. Photographic designs have no local colour.—TRANSLATOR.

“ the precision of the forms in the designs of M. Daguerre, are as perfect as it is possible they can be, and yet, at the same time, we discover in them a broad and energetic manner, and a whole equally rich in tone as in effect. The painter will obtain by this process a quick method of making collections of studies, which he could not otherwise procure without much time and labour, and in a style very far inferior, whatever might be his talents in other respects.” After combatting, by excellent arguments, the opinions of those who have imagined that photography will be injurious to our artists, and especially to our able engravers, M. Delaroche finishes his letter with this reflection, “ In conclusion, the admirable discovery of M. Daguerre, is an immense service already rendered to art.” We shall not commit the unpardonable fault of adding anything to such a testimony.

It will doubtless be remembered that among the inquiries proposed in the commencement of this Report was the question,—Are the photographic methods likely to become generally applicable ?

Without divulging what is, and what ought to remain a secret until the passing of the Bill, we may state that the tablets upon which the light delineates the admirable designs of M. Daguerre are plated surfaces, that is to say, sheets of copper covered with a thin coating of silver. It had unquestionably been preferable for the convenience of travellers, and also on the score of economy, could paper have been here employed. Paper impregnated with a solution of chloride or nitrate of silver was in fact the substance first selected by M. Daguerre. The want of sensibility, however, in this preparation, the confusion of images it produced, the uncertainty of the results, and the accidents which often marred the operation of transforming the lights into shadows, and the shadows into lights, could not fail to discourage so able an artist. Had he persisted in this first intention, his photographic designs might perhaps have figured in collec-

tions as the productions of a curious philosophical experiment, but assuredly they never would have occupied the attention of this House. Besides, if three or four francs, the price of a single plate such as M. Daguerre employs, appear too much, it is but just to add that the same plate is capable of receiving in succession a hundred different designs.

The remarkable success of M. Daguerre's actual method depends in part on the fact that he operates upon a coating of matter of extreme tenuity—on a veritable pellicle. It needs not then that we waste time upon the price of the ingredients of which this surface is composed. This price, from its smallness, would in reality be unassignable.\*

A single member only of the commission has seen the artist operate, and has operated himself. It will then be upon the personal responsibility of this Deputy that we can occupy the attention of the House with details of the Daguerreotype, viewed in reference to its simplicity of application.

The Daguerreotype, then, does not demand a single manipulation which is not perfectly easy to every person. It requires no knowledge of drawing, and does not depend upon any manual dexterity. By observing a few very simple directions, any one may succeed with the same certainty and perform as well as the author of the invention. The promptitude of the method is perhaps that which has most astonished the public. In reality ten or twelve minutes in the dull weather of winter are amply sufficient for taking a view of a monument, a section of a town or a landscape. In summer this time may be reduced one-half. Under the skies of the south not more than two or three minutes will be necessary.

\* The invention, however, is likely to suffer in its practical application from the high price set upon the apparatus at present in Paris, about 20*l*. From the descriptions now to be given it may be constructed cheaply, and by any one. "The thickness of the coating," observes a French philosopher, "will be estimated when we shall be able to weigh light, or find a third proportional between time and eternity."—TRANSLATOR.

But it is of importance to remark, that these ten or twelve minutes in winter, these five or six minutes in summer, these two or three minutes in southern regions, express merely the time during which the plate of metal is exposed to the lenticular image. To this space must be added the time of unpacking and adjusting the camera, the time spent in preparing the plate, and the few minutes necessary for the final operation of rendering the picture thus obtained insensible to the future action of light. Added together, all these different stages of the process may extend the whole period employed to thirty minutes, or three quarters of an hour. Those persons are deceived, then, who suppose that during a journey they may avail themselves of brief intervals while the carriage slowly mounts a hill, to take views of a country. They also are not less mistaken, who, struck by the curious results sometimes produced by the adhesion of the pages, or the pressure upon the engravings in very old books, have cherished dreams of reproducing and multiplying photographic designs by lithographic impressions. It is not in the moral world alone that the very perfection of certain qualities tends to defects; the maxim often finds its application in the world of art. To the perfect polish, the incalculable tenuity of the coating upon which M. Daguerre operates, are to be ascribed the finish, the grace, the harmony of these photographic designs; and to rub, to finger such designs, to subject them to the action of the press or roller, would cause their irreparable destruction. But who ever thought of forcibly pulling a ribbon of lace, or brushing the wing of a butterfly?

The academician who has for some months known the secret of the preparations upon which the beautiful designs submitted for our inspection are pencilled, has not yet thought himself entitled to put to account M. Daguerre's honourable confidence. He has deemed it no more than proper delicacy, before entering upon the wide field of research opened

to philosophers by the photographic processes, to wait until a national remuneration shall have placed in the hands of all equal means of investigation. We can do little more, therefore, in speaking of the scientific utility of our countryman's discovery, than proceed upon conjecture. The facts as to the rest are clear and palpable, removing all fear of our being deceived in their consequences.

The preparation employed by M. Daguerre is a re-agent much more sensible to the action of light than any other hitherto in use. Never have the rays of the moon, we do not say in a natural state, but even when concentrated by the most powerful lens, or in the focus of the largest reflector, been capable of producing any perceptible physical effect. The plated discs prepared by M. Daguerre, on the contrary, receive impressions from the action of the lunar rays and the succeeding operations to such an extent as permits the hope that we shall be in a situation to make photographic charts of our satellite. In other words, in a few minutes we shall be able to execute one of the longest, most tedious, and most delicate operations of astronomy.

An important branch of the sciences of experiment and calculation,—that which treats of the intensity of light, or photometry, has hitherto made little progress. The philosopher approaches pretty nearly to the determination of the comparative intensities of two luminous sources when near each other, and simultaneously visible; but the means of ascertaining this relation are imperfect when the condition of simultaneity does not exist—when the question regards a light visible at present, and one which will not be seen till after the first has disappeared.

The artificial lights, to which as standards of comparison the observer in the case in question is reduced to have recourse, seldom maintain the requisite permanence and steadiness; nor, more particularly as respects the stars, do our artificial lights possess the necessary whiteness. From these causes,

there exist very great discrepancies between the determinations of the comparative intensities of the sun and moon,—of the sun and stars, as given by men of equal scientific acquirements. Thence also the sublime inferences deducible from these latter comparisons, in relation to the humble place occupied by our luminary amid the millions of suns with which our firmament is studded, are still veiled in reserve, even in the works of those authors whose least fault is timidity.

Let us not hesitate, then, to announce the fact; the re-agents discovered by M. Daguerre will speed onwards the progress of those sciences which confer the highest honour on the human mind. By their aid the philosopher will be enabled henceforth to proceed on the principle of absolute intensities; he will compare lights by their effects. If he find it useful, the same tablet will present him with the impression of the dazzling beams of the sun, and with the pencillings of rays three hundred thousand times fainter than those of the moon—the rays of the stars. These different imprints he will equalize, either by reducing the stronger lights,—through means of excellent methods, the result of recent discoveries, the explanation of which would be here misplaced,—or by allowing the brightest rays to operate, say, only for a second, and continuing according to circumstances the action of the others for half an hour. In short, when observers apply a new instrument to the study of nature, what they expected from it has always proved little indeed compared with the series of discoveries which the instrument originated. In this instance it is upon the *unforeseen* that we are especially to reckon. Does this sentiment appear paradoxical? Some references will demonstrate its justness.

Some children casually attached two glass lenses of different focus to the opposite extremities of a tube. They thus produced an instrument which enlarged distant objects, and represented them as if near at hand. Observers of more skill



applied it with the sole—the modest hope—of seeing the stars a little better—stars known from the remotest antiquity, but which till then men had been able to study very imperfectly. Scarcely, however, is this chance gift turned towards the firmament, than myriads of new worlds are discovered. Searching into the constitution of the six planets known to the ancients, these observers find it to be analogous to the earth's—by mountains whose altitude they measure—by atmospheres whose vicissitudes they trace,—by the phenomena of the melting and renewing of polar snows, similar to those of the terrestrial poles,—by rotatory movements corresponding to those which here below regulate the alternations of day and night. Directed to Saturn, the tube of the children of the Middleburgh spectacle-maker disclosed there a phenomenon the strangeness of which exceeded whatever the most enthusiastic imaginings had been able to realize.

We mean that ring—or, if the expression be better—that bridge without supports, 71,000 leagues in span, and 11,000 leagues in breadth, which environs on every side the globe of the planet, without approaching it in any part nearer than 9,000 leagues. Had any one foreseen, that, applied to the observation of Jupiter's four moons, this tube would enable us to detect the rays of light in their speed of 80,000 leagues per second,—that attached to graduated instruments it would serve to demonstrate the existence of no stars whose light comes to us in less than three years—that in short, following out with its assistance certain observations, certain analogies we should have attained within immense probability,—the conclusion that the ray by which at any given instant we descry certain nebulosities has parted on its journey from these regions several millions of years before,—in other terms, that these nebulosities from the successive propagation of light would be visible from the earth several millions of years after their entire annihilation !

The telescope for near objects—the *microscope*—would fur-

nish subjects of remarkable analogies, for nature is not less admirable in her minuteness than in her immensity. Applied at first to the observation of certain insects whose forms naturalists wished merely to enlarge in order more correctly to reproduce them by the graving tool, the microscope unveiled, subsequently and unexpectedly, in air, in water, in all liquids those animalcules, those infusories, those strange reproductions in which we may one day hope to grasp the first principles of a rational explanation of the phenomena of life. Recently directed to the minute fragments of different stones hitherto ranked among the hardest, the most compact of which the crust of our globe is composed, the microscope has disclosed to the eyes of astonished observers the fact that these stones have lived—that they are a compost formed of millions of millions of microscopic animals kneaded together.

This digression, it will be recollected, was intended to undeceive those who would wrongfully shut up the scientific applications of M. Daguerre's processes, within the circuit of what is actually known, the outline of which we have traced. But we hope differently—and do not facts already justify our anticipations? We might speak, for example, of certain ideas which we entertain of methods of rapid investigation which topography might borrow from photographic principles. I shall attain my object more directly, however, by introducing here a curious remark related to us yesterday by M. Daguerre. According to his observations, the hours of the morning and those of the evening equally distant from mid-day, and consequently corresponding to the same altitudes of the sun above the horizon, are not alike favourable to the production of photographic images. For example, at all seasons of the year, and under circumstances of atmospherical influence in appearance the same, images are formed with more rapidity at eleven o'clock in the morning than at five in the afternoon, at eight o'clock than at four, at nine than at three. Let us suppose this result verified, and the meteor-

ologist obtains an additional principle, one element more than he possessed for the construction of his tables. Thus, to former observations on the state of the thermometer, barometer, hygrometer, and transparency of the atmosphere, there remains to be added an element not detected by the instruments previously in use,—an account must be taken of a particular absorption, which cannot be without influence upon many other phenomena, on those even connected with physiology and medicine.

Gentlemen ; we have thus endeavoured to collect into one view, whatever the discovery of M. Daguerre presents that is most interesting under the four heads of Novelty, Utility to the Arts, Rapidity of Execution, and the valuable resources which it offers to science ; we have earnestly laboured to make you participate in our convictions, because these are lively and sincere,—because we have examined all,—studied all with the sacred faithfulness imposed upon us by your suffrages—because, had it been possible to misconceive the importance of the Daguerréotype and the place it is destined to hold in the estimation of men, all our doubts would have ceased on perceiving the eagerness of foreign nations to lay hold of an erroneous date, of a doubtful fact, of the slightest pretext, in order to stir up questions of priority for the purpose of adding to their own crown of discovery, the beautiful ornament which the photographic inventions will ever form. Let us not forget to proclaim that all discussion on this point is now at an end, and must cease, less from the claims to authentic priority produced by MM. Niepce and Daguerre than by reason of the incredible perfection of the results at which M. Daguerre has arrived.\*

Were it necessary, we could easily produce here the evidence of the most eminent men in England and Germany, before whose praise all that we have said in favour of our

\* See Preface. The Translator had marked this for a long note, but time presses.

countrymen would fade as into nothing. This discovery France has adopted ; from the first moment she has cherished a pride in liberally bestowing it—a gift to the whole world. Still we were far from being surprised at a sentiment almost generally entertained by the public, arising from a passage in the first exposition laid before this House, which, being misapprehended, seemed to imply that the Administration had trafficked with the inventor—that the pecuniary conditions of the contract now proposed for your sanction were the result of a chaffering. Gentlemen, it is of importance to place these facts in their proper light.

The member of this Chamber to whom the Ministry gave full powers never bargained with M. Daguerre. Their communications had solely for object to determine whether the recompense so justly due to the accomplished artist should be a pension or a sum paid at once. From the first, M. Daguerre perceived that the payment of a stipulated sum might give to the transaction the base character of a sale. The case was different with a pension. By a pension you recompense the warrior who has been wounded in the field, and the magistrate who has grown grey on the Bench ; it is thus that you honour the families of Cuvier—of Jussieu—of Champollion. Reflections like these could not fail to present themselves to a man of his exalted character, and M. Daguerre decided on a pension. All other arrangements were left to the Minister for the Home Department. M. Daguerre himself fixed the amount at 8,000 *frs.*\* to be divided equally between himself and his partner, M. Niepce, junr. The proportion payable to M. Daguerre has since been raised to 6,000 *frs.* (making 10,000 in all), both on account of the condition specially imposed upon that artist of publishing the secret of painting and illuminating the Dioramic views, and making known all future improvements with which he may enrich his photo-

\* Three hundred guineas.

graphic methods.\* The importance of this latter engagement will certainly not appear doubtful to any person when we inform you, for instance, that a very slight advance beyond his present progress will enable M. Daguerre to apply his processes to executing portraits from life. Far from fearing that M. Daguerre will leave to other experiments the care of adding to his actual success, we have rather sought how to moderate his ardour. Such, and we frankly confess it, was the motive which induced us to desire that you would declare the pension *unattachable* and *unalienable*. This amendment, however, we now perceive to be unnecessary, an existing law recognising the principle.

Your commission have now only to recommend unani-  
mously that you adopt simply, and without alteration, the bill proposed by the Government.

---

## CHAMBER OF PEERS.

SITTING OF THE 30th JULY, 1839.

REPORT presented to the Chamber by M. Gay Lussac, in name of a special commission charged with the examination of the Bill relative to the purchase of the process of M. Daguerre for fixing the images of the Camera Obscura.†

MY LORDS,

Whatever conduces to the progress of civilization, to the physical or moral well-being of man, ought to be the constant object of the solicitude of a Government alive to the

\* See Note (2) at end.

† The Special Commission was composed of the following Peers: Barons Athalin, Besson, Gay Lussac, the Marquis De Laplace, Vicomte Siméon, Baron Thénard, and the Comte de Noé.

grandeur of those destinies which have been confided to its care ; and they who by happy efforts aid this noble cause, ought to obtain honourable rewards for their success.

Thus already do the laws, guardians of property in literature and the useful arts, secure to the authors benefits corresponding to the services rendered to society — a mode of remuneration so much the more just, so much the more honourable, that it resolves itself into a contribution purely voluntary in exchange for services rendered—and that it is independent of the caprices of favour.

If, however, this mode of encouragement be the best in the majority of instances, there are some cases in which it is impracticable or at least insufficient ; and finally there are others in which great discoveries demand the most splendid and solemn recompenses.

My lords, the discovery of M. Daguerre appears to us, and such it has been considered both by His Majesty's Government who have made it the subject of a Bill now laid before you, and by the Chamber of Deputies, who have already given to the Bill their legislative sanction.

The discovery of M. Daguerre is known to you by its results submitted to the House ; and by the Report presented to the Chamber of Deputies by the illustrious philosopher to whom the secret had been confided. It is the art of fixing the image itself produced by the camera obscura on a metallic surface, and preserving it on the tablet.

We hasten, however, to explain, without wishing in aught to lessen the merit of this beautiful invention, that the palette of the painter is not very rich in colour—black and white compose the whole. The image in its natural and varied colours may remain long—perhaps for ever—a thing hidden from human sagacity. But let us not rashly circumscribe knowledge within impassable bournes. The successful efforts of M. Daguerre have disclosed a new order of possibilities.

Called to state our opinion of the importance and consequences of M. Daguerre's invention, we have formed that opinion on the perfection of the results—on the report of M. Arago to the Chamber of Deputies—and on fresh communications received both from that philosopher and from the inventor himself. Our conviction then as to the importance of the new process is complete, and we should be happy could we persuade the House to participate in the same persuasion.

It is certain that through the discovery in question the Physical Science of the present day has obtained possession of a re-agent sensible in a very extraordinary degree to luminous influences—of a new instrument which will become, for the intensity of light and all the phenomena of luminous bodies, what the microscope is for minute objects—which will supply means for new researches and further discoveries. Already this re-agent has been impressed very distinctly by the feeble light of the moon, and the hope is entertained that a lunar chart may be traced by the Satellite herself.

My Lords, you have had an opportunity of convincing yourselves by proofs submitted to your inspection, that bas reliefs, statues, monuments, in a word, inanimate nature can be rendered, with a degree of perfection unapproachable by the ordinary processes of drawing and painting—a perfection equal to that of nature, since the impressions obtained are in reality a faithful image of nature herself.

The perspective of a landscape—of every object—is reproduced with mathematical exactness: no occurrence, no feature—even though unperceived—can escape the eye and pencil of this new painter; and as a few minutes are sufficient for his work, even a field of battle in all its phases may be delineated with a precision unattainable by any other means.

The arts of industry—for the representation of forms; linear design—for perfect models of perspective and the

distribution of light and shadow; the natural sciences—for the study of species and their organization,—all will certainly make numerous applications of the new processes. In fine, the problem of its adaptation to portrait painting is almost resolved, and the difficulties which yet remain to be overcome being ascertained, seem to imply no doubt of success. Nevertheless, it must not be forgotten that coloured objects are not reproduced with their proper tints, and that the different luminous rays acting in the same manner upon M. Daguerre's re-agent, the harmony of light and shadow in coloured objects is necessarily impaired. This is a line of demarcation traced by Nature herself to the new system.

Such, my Lords, are the acquisitions already secured by this discovery—such the hopes on the point of being realized. Information, however, was required relative to the practical application of the process, and the Commission thought that it could not be obtained from a surer or more authentic source than the mouth of the honourable Deputy on whom the discoverer had first bestowed his confidence, and at a later period, from the Minister for the Home Department. M. Arago, on the request of the President of your Commission, has, in the other House, confirmed by new details the substance of his previous interesting Report.

Thus it is certain that the application of Daguerre's method requires only a very short time, and after the first outlay for the apparatus, about 400 f.\* the expense is trifling. After a very few trials every one must succeed without fail in producing the most exquisite specimens of art. M. Arago himself, for instance, after the secret had been disclosed to him, executed, on his first essay, a master-piece, which we should have seen here, had it not perished in the flames when the Diorama was consumed.

\* 12*l.* sterling.



If additional evidence were needed, your Reporter might add that M. Daguerre has made him also the depository of his secret, and has described to him all its operations. He can assure this House that the process is not expensive, and that it can be easily executed by those unacquainted with drawing, more especially after the instructions which M. Daguerre will be bound to publish.

Your Reporter will further add, that although he has not, like his honourable friend, M. Arago, repeated the process, he considers it, from description, to be most difficult in the discovery, and as requiring, in order to attain the degree of perfection acquired by M. Daguerre, much time, trials without number, and above all, that indomitable perseverance which failure serves only to stimulate, and which is never found but in great minds. The process in fact is composed of various successive operations, to appearance not necessarily connected, while the final result does not seem progressively to advance after each, becoming visible only when the whole series is concluded. Assuredly, had M. Daguerre wished to keep his process secret, or confine it to a few, its discovery by others was little to be apprehended. But it may now perhaps be asked, and indeed the questions have been urged,—Why, seeing his process is so difficult in the discovery, has not M. Daguerre preferred retaining it; and why, in the face of so many wise laws, protective of rights such as this, does government propose to purchase the secret, in order to publish it to the world? We will reply to these two inquiries.

The principal advantage of Daguerre's process consists in obtaining quickly and yet with the utmost exactness, representations of objects, whether to preserve this identical image, or to reproduce it by engraving or lithography. Hence, it is conceived that, limited to the possession of a single individual, an art like this could not find sufficient exercise.

On the contrary, given to the public, this process will

receive in the hands of the painter, architect, traveller, naturalist, innumerable applications, all more or less useful to mankind. Lastly, as the secret of an individual, the invention itself would long remain stationary, and, perhaps might retrograde; rendered public it will be extended and improved by a general emulation.

Thus, from these various considerations, it was thought desirable that this process should become public property. From a different motive it merited the attention of government, and ought to procure for its author a conspicuous reward.

To those who are not insensible to national glory,—who know that a people shine with greater splendour among the nations of the earth, only as they have realized a higher advancement in civilization—to those we say, the process of M. Daguerre is a noble discovery. It is the origin of a new art in the midst of an old civilization; an art which will constitute an era, and be preserved as a title of glory. And shall it descend to posterity companioned by ingratitude? Let it rather stand forth a splendid evidence of the protection which the Chambers—the Government of July—the whole country afford to great inventions.

It is in reality an act of national munificence which consecrates the Bill in favour of M. Daguerre. We have given it our unanimous assent, yet not without marking how elevated and honourable is a reward voted by the country. And this we have done on purpose to remind the nation,—not without some sad remembrances—that France has not always shown herself so grateful, and that too many useful labours—too many works of genius—have often procured for their authors only a barren glory. These are not accusations which we urge,—they are errors which we deplore in order now to avoid a new one.

My Lords, after having appreciated, to the best of our judgment, the importance of the discovery of M. Daguerre,

we rest convinced that it is new, full of interest, rich in consequences, and finally that it is worthy of the distinguished honour of the national remuneration which has already been voted in the Chamber of Deputies. The Commission is unanimous for adopting the Bill simply and without alteration.

## CHAPTER II.

Practical and Historical Details.—Partnership of the two Discoverers.—Account of Niepce's Processes.—His own Notes.—Daguerre's Remarks.—Asphaltum the Substance employed for receiving the Impressions of Light—This the old System.—The Solvent.—Its Application.—Description of some Results.—Additional Notices.—Daguerre's improvements on Niepce's Processes.—Correspondence.—Experiments.—Disappointments.—Daguerre unquestionably prior to Niepce in the application of Iodine.

So early as 1814, M. Niepce engaged in a series of experiments to determine the possibility of fixing the images in the *camera obscura*; but more particularly to perfect his methods of copying engravings, applied upon substances sensible to the influence of light.

In 1824, M. Daguerre also was making researches of an analogous description, with this difference, that his experiments were directed solely to the fixation of the image obtained by the camera, for he regarded the copying of engravings by these processes as of no importance to art.

In 1829, M. Daguerre entered into partnership with M. Niepce in order that they might prosecute the subject in common.

M. Niepce had named his discovery Heliography,\* and wrote a description of it to be communicated to M. Daguerre. To this account which follows, M. Daguerre now adds a few notes, chiefly including his remarks made to M. Niepce himself. These notes are not produced for the purpose of criticism, but simply with a view to explain the true state of photogenic science when this partnership was formed. From the description of Niepce, his method might other-

\* Delineation by the sun.

wise appear to have reached a degree of perfection, which, with all the subsequent improvements even, it is very far from having yet attained.

“ DESCRIPTION OF HELIOGRAPHY, BY J. N. NIEPCE.

THE discovery which I have made, and to which I give the name Heliography, consists in reproducing *spontaneously* by the action of light, with gradations of tints from black to white,\* the images received by the *Camera Obscura*.

*Fundamental Principle of the Discovery.*

Light, in its state of composition and decomposition, acts chemically upon bodies. It is absorbed, it combines with them, and communicates to them new properties. Thus it augments the natural consistency of some of these bodies: it solidifies them even, and renders them more or less insoluble according to the duration or intensity of its action.

Such, in a few words, is the principle of the discovery.

*Primary Material.—Preparation.*

The substance or primary matter I employ,—that which has succeeded best with me, and which concurs most immediately to produce the effect is *Asphaltum* or Bitumen of Judea, prepared in the following manner.

I fill a wine-glass about half with this pulverised bitumen. I pour upon it drop by drop the essential oil of lavender till the bitumen can absorb no more, and till it be completely saturated. I afterwards add as much more of the essential oil as causes the whole to stand about three lines above the mixture, which is then covered and submitted to a gentle heat until the whole essential oil be saturated with the colouring matter of the bitumen. If this varnish should not yet

\* The clearest tint which is obtained by this process is not *white*.—  
M. DAGUERRE.

possess the requisite consistency, it is to be allowed to evaporate atmospherically in a shallow dish, care being taken to protect it from moisture, by which it is injured, and finally decomposed. If in winter, or during rainy weather, the precaution is doubly necessary.

A small quantity of this varnish applied cold, with a light roll of very soft skin, to a highly polished tablet of plated silver, will impart to it a fine vermilion colour, and will cover it with a very thin and equal coating;\* the plate is afterwards to be placed upon heated iron, which is wrapped round with several folds of paper, whence by this means all the moisture has previously been expelled. When the varnish has ceased to simmer, the plate is withdrawn, and left to cool and dry in a gentle temperature, secured against contact with a damp atmosphere. I ought not to omit mentioning that it is principally in applying the varnish that this last precaution is indispensable. In this part of the operation, a light circle of metal, with a handle in the centre, should be held before the mouth in order to condense the moisture of the respiration.

The plate thus prepared may be immediately submitted in the focus of the camera to the impressions of the luminous fluid. But even, after having been thus exposed, a length of time sufficient for receiving the impressions of external objects, nothing is externally apparent to show that these impressions exist. The forms of the future picture remain still invisible.† The next operation then is to disengage the shrouded imagery, and this is accomplished by a solvent.

\* It is impossible by any such means to spread a coating sufficiently equal to obtain in the camera that delicacy required by the modifications of light.—M. DAGUERRE.

† If the image were altogether invisible, there could be no result. M. Niepce means that the impression is extremely feeble, but if there be no appearance of action at all, the operation has not succeeded.—M. DAGUERRE.

*Of the Solvent, and Manner of its Preparation.*

As the solvent must be adapted to the purposes for which it is designed, the task is difficult to fix with certainty the proportions of its components; but in all cases it is better that it be too weak than too strong.\* That which I employ in preference, is composed of one part, not by weight but volume, of essential oil of lavender poured upon ten parts, by measure also, of oil of white petroleum. The mixture which is first of a milky consistency, becomes perfectly clear in two or three days. This compound will act several times in succession. It loses its dissolving power only when it approaches the point of saturation; this state is readily distinguished by an opaque appearance and dark brown colour.

The plate or tablet varnished as described, and exposed as directed, having been withdrawn from the camera, a vessel of tinned iron somewhat larger than it, and about an inch deep, is previously prepared and filled with the solvent to a depth sufficient to cover the plate. Into this liquid the tablet is plunged, and the operator, observing it by reflected light, begins to perceive the images of the objects to which it had been exposed, gradually unfolding their forms, though still veiled by the supernatant fluid continually becoming darker from saturation with varnish. The plate is then lifted out and held in a vertical position till as much as possible of the solvent has been allowed to drop away. When the dropping has ceased, we proceed to the last and not least important operation.

*Washing.—Manner of Procedure.*

A very simple apparatus answers for this operation, namely, a board about four feet long, and somewhat broader than

\* These two extremes have their respective inconveniences. In the former he image does not re-appear with sufficient brilliancy; in the latter it is completely destroyed.—M. DAGUERRE.

the tablet. Along each side of this board runs a ledge or border projecting two inches above its surface. It is fixed to a support by hinges at its upper extremity, in such a manner as permits its angle of inclination to be varied at pleasure, that the water thrown upon it may run off with the requisite velocity. The lower end rests upon the vessel intended to receive the water as it flows down.

The tablet is carefully placed upon the board thus inclined, and is prevented from slipping down by two little blocks, which ought not to exceed the thickness of plate, that there may be no ripple in the descending stream. Tepid water should be used in a cold day. The water must by no means be poured directly upon the plate, but above it on the board, so that descending in a stream it may clear away all the remaining solvent that may yet adhere to the varnish.

Now, at length, the picture is completely disengaged, and if the different operations have been carefully performed, the outlines will be found to possess great neatness, especially if the images have been received in a camera with achromatic lenses.\*

When the plate is removed to be dried, which must be done with great care, by a gentle evaporation, it must be kept protected from humidity, and covered up from the action of light.

#### *Applications of the Heliographic Processes.*

The varnish employed may be applied indifferently to stone, metal, and glass, without any change in the manipulation. I shall speak, however, only of its application to plated silver and glass; as to impressions on copper, I may just state that a small quantity of wax dissolved in essential

\* Here M. Niepce seems to speak hypothetically; for experience proves that the achromatic camera, though it gives greater purity to the images, does not impart that superior neatness and sharpness to the outlines which were anticipated from its operation.—M. DAGUERRE.



oil of lavender, may in this case be added with advantage to the varnish already described.\*

Of all substances hitherto tried, silver plated upon copper appears to me to be the best adapted for reproducing images, by reason of its whiteness and structure. One thing is certain, that after the washing, provided the impression has been well dried, the result obtained is already satisfactory. It were, however, to be desired that, by blackening the plate, we could obtain all the gradations of tones from black to white. I have, therefore, turned my attention to this subject, and employed at first *liquid sulphate of potassa*. But, when concentrated, it attacks the varnish; and, if reduced with water, it only reddens the metal. This twofold defect obliged me to give it up. The substance which I now employ is iodine,† which possesses the property of evaporating at the temperature of the atmosphere. In order to blacken the plate by this process, we have only to place it upright against one of the sides of a box, open above, and place some grains of iodine in a little groove cut in the bottom, in the direction

\* It is necessary to remark that the "impressions on copper," of which M. Niepce here speaks, have reference solely to copies of engravings placed above the prepared plate, and thus exposed to the full action of the sun's light. The application of the wax, as mentioned by him, would have neutralized the effect of the decomposition of the bitumen in the camera into which the light enters, much weakened. But the presence of this wax was not an obstacle in copying engravings exposed three or four hours to the direct rays of the sun.—M. DAGUERRE.

† It is of importance to point out to the reader that the use of iodine here made by M. Niepce only to *blacken* his plates, proves that he was not acquainted with the property possessed by this substance, when in contact with silver, of being decomposed by light. On the contrary, he used it as a means of fixing his sketches.—M. DAGUERRE.

[Daguerre's own method, as the reader will hereafter understand, depends on this decomposition of iodine. This is the great distinction between the old and new processes—between Niepce's and Daguerre's systems—in a word, between the approximation and the real principle.—TRANSLATOR.]

of the opposite side. The box is then covered with a glass, to judge of the slow but certain effect. The varnish may then be removed by spirit of wine, and there no longer remains any trace of the original impression. As this process is still quite new to me, I confine my remarks to this simple explanation, waiting till experience shall enable me to enter upon more circumstantial details.

Two experiments in landscape upon glass, by means of the camera, gave me results which, though very imperfect, appear deserving of notice here, because this species of application may be brought more easily to perfection, and become in the sequel a most interesting department of Heliography.

In one of these trials, the light having acted with less intensity, removed the varnish in a way which exhibited a more marked gradation of tone, so that, seen by transmitted rays, the landscape produced, to a certain extent, the well-known effects of the Diorama.\*

In the second trial, on the contrary, in which the action of the luminous fluid had been more intense, the parts acted upon by the strongest lights, not having been attacked by the solvent, remain transparent, and the difference of tones results entirely from the relative thickness of the coatings of varnish.

If this landscape be viewed by *reflection* in a mirror, on

\* M. Daguerre does not see what relation can exist between the effect here described by M. Niepce and the pictures of the Diorama.

[The reader will find in M. Daguerre's own description of Dioramic painting, that much of its surprising effect depends upon the transparency of the ground; both reflected and transmitted illumination throws light up, or, as the case may be, deadens the effect of these pictures. A medium, or (if the expression be allowed) canvas of glass, with a picture sketched in varnishes of different thickness, and, consequently, different transparency, as in the case of Niepce's experiment, would produce the same result, though in a less degree, owing to the absence of colour.—TRANSLATOR.]

the varnished side, and at a certain angle, the effect is striking, while, seen by transmission, it presents only confused and shapeless imagery ; but what is really surprising, in this position the mimic tracery seems to affect the *local colours* of certain objects.\*

In reflecting upon this remarkable fact, I have sometimes thought that consequences might thence be deduced connected with Newton's theory of coloured rings. It is sufficient further to suppose that any prismatic ray—the green ray for instance—in acting upon the substance of the varnish and combining with it, imparts the degree of solubility, which, after the double operation of the solvent and the washing, is required to *reflect the green colour*. But it remains for experiment, which alone can decide, to determine what truth there may be in this theory : but the circumstance appears to me sufficiently interesting to excite new researches, and to merit more profound enquiry.†

#### *Observations and Additions.*

Although doubtless there be nothing difficult in the processes just described, yet it must not be expected that one will succeed at once. I am of opinion then that it is better to begin by copying engravings in *full daylight*, before attempting the camera, and by a very simple procedure, as follows :—

The engraving must be varnished, but on the *back* so as to render it quite transparent. When perfectly dry it is applied face upwards to a tablet prepared as already directed,

\* M. Daguerre has often remarked this effect of colour, but could never regard it as the effect of the coloured rays in the camera.

[M. Daguerre is right ; extremely thin laminæ of all transparent substances, as a coating of varnish upon glass, give forth prismatic rays, on an optical principle obvious enough.—TRANSLATOR.]

† [The reader will understand the importance attached to these trifling indications of colour, on reflecting that to obtain colour as well as form, is the great desideratum wanted to perfect the photographic process.—TRANSLATOR.]

and made perfectly smooth and flat by means of a plate of glass, and to diminish the pressure—the apparatus is inclined at an angle of  $45^{\circ}$ . With two engravings thus prepared, and four small tablets plated on both sides, one may make several experiments in one day, even in the winter or in dull weather, provided the apparatus be protected from the cold and moisture, which latter, I repeat, so injures the varnish as to detach it in flakes from the plate when plunged into the solvent. This prevents me from making use of the camera during the winter season. By repeating these trials one will soon become quite expert in all the processes of manipulation.

Respecting the manner of applying the varnish, I observe that it ought to be of such consistence as will form a compact washing, and should be laid on as thin as possible. The former quality enables it better to resist the solvent; the latter renders it more sensible to the solar action. With regard to the iodine for blackening heliographic sketches, just as in the case of acid for engraving on copper, it is essential that the varnish after the washing be as described in the second trial on glass, because the lights resist the solvent in the one case, and the vapours of the iodine in the other, that is, the resistance is greatest in those places which are most transparent;\* and it is only on this condition, even with the best apparatus, that one can hope completely to succeed.†

\* The sketch which gave rise to this remark was for a length of time exposed to the action of light in the camera, and although M. Niepce here speaks of *iodine* to blacken, and *acid* to engrave, supposing the impression to be on copper, these two operations could have brought out no gradation of tints. In reality the images having been obtained by a greater or less degree of tenuity in the coatings of varnish, according as it had been more or less acted upon by the light, it is impossible that acid could act upon metal in a manner analogous. Neither did M. Niepce ever make an engraving from a sketch obtained in the camera.—M. DAGUERRE.

† The best optical apparatus could not remove the obstacle mentioned in the preceding note.—M. DAGUERRE.

In speaking of experiments made in open day, and without the camera, I have said nothing of my experiments of this kind on glass. I shall here supply this omission, that I may not forget an improvement peculiar to this description of heliography. It consists simply in placing a black paper under the glass, and interposing a frame of pasteboard between the varnished surface of the glass plate and the engraving, which is previously to be well fixed and stretched upon the frame. By this arrangement heliographic impressions appear much more lively than upon a white ground, and the effect is more speedily produced. Secondly, the varnish is not liable to be injured by coming into immediate contact with the back of the engraving, a disadvantage, which otherwise in the case of the metal plate it is difficult to avoid, especially in warm weather, the most favourable season for these experiments.

But this inconvenience is amply compensated by the superior strength which drawings upon silver plate possess for enduring the process of washing; while it is rare that this operation does not more or less damage drawings upon glass, a substance to which, from its high polish, the varnish more weakly adheres. It becomes an object, then, how to remedy this defect by giving more unctuousity to the varnish, and this, I believe, I have accomplished, at least so far as I can venture to infer from trials still too recent and too few for perfect conviction. This new varnish is composed of *Bitumen from Judea dissolved in animal oil of Dippel*, which is allowed to evaporate by atmospheric temperature till of the required consistency. This composition is more unctuous, of greater tenacity, and higher colour than the other, and after being applied it can immediately be submitted to the action of the light, which appears to render it solid more quickly from the greater volatility of the animal oil.\*

\* But this very property diminishes still farther the resources of the process as respects the lights of the drawings thus obtained.—M. DAGUERRE.

I have retained a copy of this paper, and transmitted the original to M. Daguerre, 5th December, 1829.

(Signed)

J. N. NIEPCE."

---

MODIFICATIONS AND IMPROVEMENTS MADE UPON THE  
PRECEDING PROCESSES, BY M. DAGUERRE.

THE substance which ought to be used in preference to Bitumen is the residuum obtained by the evaporation of the essential oil of lavender applied in an extremely thin wash by means of dissolution in alcohol.

Although bituminous and resinous substances without any exception are all endowed with the same property—that of being affected by the influence of light, the preference ought to be given to those which are the most unctuous, because they impart greater adhesion to the drawings. Several essential oils lose this character when they are exposed to too strong a heat.

It is not, however, from its prompt decomposition, that we are to prefer the essential oil of lavender. There are rosins for instance, which being dissolved in alcohol, and spread upon glass or metal, leave by the evaporation of the spirit, a coating very white, and infinitely more sensible to radiation, which is the cause of the decomposition. But this greater sensibility to light caused by a quicker evaporation, renders also the images thus obtained more liable to injury from the very same agency which created them. They grow faint, and finally disappear altogether, when exposed even but for a few months to the sun. The residuum of the essential oil of lavender, pos-

sesses greater fixity, without, however, being altogether impervious to the eroding effects of a direct exposure to the sun's light.

To obtain this residuum, the essence is evaporated in a shallow dish by heat, till the residuum acquire such consistency, that when cold it rings on being struck with the point of a knife, and flies off in pieces when separated from the dish. A small quantity of this material is afterwards to be dissolved in alcohol, or ether; the solution ought to be very transparent, and of a citron-yellow colour. The clearer the solution, the more delicate will be the coating on the plate: it must not, however, be too clear, because it could not thicken or spread out into a white coat—requisites indispensable for obtaining a good effect in photographic designs. The use of the alcohol in ether is merely to facilitate the application of the residuum under a form of extreme tenuity and division, for the spirit is entirely evaporated before the light impresses its tracery upon the sketch.

In order to obtain greater vigour, the metal ought to be burnished: sketches upon glass have more charm, and above all, much greater delicacy.

Before commencing operations, the experimenter must be careful to have his glass or metal perfectly clean. For this purpose he may use alcohol with emery-powder exceedingly fine, and applied by means of cotton wool; but this part of the process must always be concluded by dry-polishing, that not a trace of liquid may remain.

The tablet being thus prepared, in order to supply the wash or coating, the canvas of the future picture, the plate of metal or glass is held in one hand, and with the other pour upon it the solution, (which for this purpose should be contained in a small flask with a wide mouth) so that it may rapidly flow over, and cover the whole surface of the plate. At first it is necessary to hold the plate a little inclined; but as soon as the solution is poured on, and has ceased to

flow, the plate is raised perpendicularly. The finger is then passed behind and below the plate, in order to draw off a portion of the liquid which, tending always to ascend, would double the thickness of the covering; the finger must be wiped each time, and be passed very rapidly along the whole length of the plate from below, and on the side opposite the coating. When the liquid has ceased to run, the plate is put aside to dry in the dark, for otherwise the light would destroy the sensibility of the preparation.

The coating being thus well dried, the plate may be placed in the camera obscura. It is allowed to remain there a sufficient time for the production of photographic images—a space which cannot be determinately fixed, because it depends upon the degree of intensity of the light cast upon the objects to be delineated. However, for a landscape, the time cannot be less than seven or eight hours, and about three hours for single monuments or other objects which are strongly illuminated by the sun, or otherwise very bright in themselves. Still these data are but approximations, for the seasons and the different hours of the day produce very considerable modifications of the principles.\*

When one operates on glass, it is necessary, in order to increase the light, to place it upon a sheet of paper; but, that this reflection be not confused, we must place the surface opposite the coated side, directly upon the paper, touching it in every point. To accomplish this, we must previously stretch the paper upon a perfectly flat board, having taken care to select a plate, even in its surface, and very white in colour.

When the sketch has remained the proper time in the camera, it is to be withdrawn, care always being taken to protect it from the light.

As it very often happens that on being removed from the

\* See page 18, near the bottom.



camera the plate gives no indication of the images traced upon it, our next operation must be to evoke these hidden forms.\*

Provide a vessel of tinned copper or sheet-iron larger than your tablet, and having all round a ledge or border 50 millimetres in depth. Fill this three-quarters full with oil of petroleum; fix your tablet by the back to a piece of wood which completely covers the vessel of oil, placing it so that the tablet, face downwards, is over but not touching the oil. In this position the petroleum evaporating, penetrates entirely the coating of the tablet in those places on which the action of the light has been feeble, that is, in the portions of the picture corresponding to the shadows, imparting to them a transparency, as if nothing were there: those points, on the contrary, upon which the light has acted with all its intensity, and which consequently express the lights on the natural objects represented, remain unchanged, because they resist the action of the petroleum.

In this manner, the whole harmony and gradation of tints are brought out by the varied action of the vapour upon the coating of the tablet, in proportion as that has received the impressions of light.

The design must be examined from time to time, and withdrawn as soon as a vigorous effect is obtained. For, urging the action too far, even the strongest lights will be attacked by the vaporization and will disappear, to the ruin of the piece. The picture being finished, a glass is placed over it as a protection against the dust, which is first to be blown away if any has fallen upon the tablet during the operation. Placing the designs under glass will also preserve the silver plating from being injured by the vapours which blacken or corrode the metal.

\* [There seems to be here a contradiction between Daguerre's remarks on Niepce's process and the description of his own improvements. See M. Daguerre's note, p. 35.—TRANSLATOR.]

*Recapitulation.*

It has been remarked above, all bitumens, all resins, and all residua of essential oils are decomposable by light in a very sensible degree : to produce this effect it is only required to spread them in very thin coatings over a proper surface, and to find a solvent which suits them. We may employ as dissolvents oil of petroleum, all the essential oils, alcohol, the ethers, and caloric.

M. Niepce plunged the tablet, covered with a varnish of bitumen, into a liquid solvent. But such a mode of applying the solvent is rarely in harmony with the diminished intensity of the light in photographic sketches obtained by the camera.

It ever happens that the dissolvent is too strong or too weak. In the former case the design is destroyed by the entire removal of the varnish ; in the latter, the images are not sufficiently brought out, and the design remains indistinct.

The effect of a solvent into which a photographic design is immersed, produces the removal of the varnish in those points where the solar action has been weak, or indeed according to the nature of the solvent, a contrary effect follows, that is to say, the points strongly acted upon by the solar rays, namely, the lights of the picture, are eroded, while the shadows remain untouched. This takes place for instance when alcohol is used instead of an essential oil as a dissolvent.

Solvents by evaporation or by the effects of caloric are much preferable. Their action can always be arrested at pleasure. But in this case it is indispensable that the ground or coating do not act as a varnish, it must be tough and as white as possible. The vapour of the solvent merely penetrates the coating and destroys its texture, in proportion to the greater or less intensity of the light by which the

design was impressed. This manner of operating gives a gradation of tone altogether impossible to be attained by immersing the design in any solvent.

Numerous experiments made by the author prove that light cannot fall upon a body without leaving traces of decomposition on the surface upon which it impinges. But these experiments have also demonstrated to him that these same bodies possess the power of restoring and renewing in a great measure their previous loss in darkness, provided the light has not effected a total decomposition.\*

Any one may be convinced of this, by taking two plates, prepared as already described, and exposing them to photographic influences of exactly the same kind and duration. When it is judged that the light has produced its effects, and that both are impressed with the same, or nearly the same

\* [Instances of the truth of these remarks will occur to every reader. How often are interesting remains, as coins, utensils, bones, and even manuscripts, dug up in dry situations, protected from light, and seemingly in good preservation? A short exposure to daylight, dissolves the charm with the substances themselves. I had once the good fortune to be present at the opening of the grave of an ancient British chief, whose remains had slumbered in undisturbed repose for eighteen centuries. A rude urn, a well-formed battle-axe of stone, and a bronze dagger, were apparently in excellent condition. The dagger was particularly beautiful; its ivory handle, even to the ornamented tassel of white bristles, all seemed perfect as when grasped by the wearer. But while we looked,—like the air-drawn dagger of Macbeth,—it melted away on exposure to photogenic, or rather phototheiric process of exposure to day-light, leaving behind only regret—and a fragment of the corroded blade. The state of the atmosphere, particularly as to its humidity or dryness, has doubtless a very considerable share in such changes as Daguerre refers to. Still his principles are exceedingly valuable, and if followed out might lead to important results in physiology. Why, for instance, the beautiful skies of his own France are so rapidly destructive of youthful beauty in one sex—the complexion and form of the human being in different climates—the different qualities of vegetable productions, varying with the light of the regions in which they grow—the plumage of birds,—following to a certain extent the same principle, &c. &c.—are often illustrations of the same principle.—TRANSLATOR.]

imagery, let both be withdrawn from the camera. Let one be now exposed to the immediate action of the dissolvent, but let the other be preserved carefully in the dark for some days, after which let it be subjected also to the solvent. It will be seen that the result obtained from the second does not resemble the effects on the first plate.

It may thence be concluded that a large portion of bodies, and without any doubt all varnishes, would perish much more rapidly, but for this property which they possess of renewing in the shade the waste produced in them by the action of light.

---

It has already been explained in the note prefixed to N. Niepce's description of his process, that a provisional act of association was entered into between him and M. Daguerre in the month of December, 1829. In that act M. Daguerre became bound to perfect the system of M. Niepce, and to communicate to him all the information regarding the adaptations which he had made in the applications of the camera obscura. M. Daguerre has judged it necessary to insert here an extract from the correspondence of M. Niepce, in order to prove that the latter had no part in the discovery of the Daguerriotype, properly so called, or true method of photogenic delineation.

In fact, it will be seen from the correspondence of M. Niepce that M. Daguerre had pointed out to him the effects of light upon iodine, when in contact with silver, in a letter dated the 21st May, 1824, of which M. Niepce acknowledges the reception in his letter of the 24th June following. In that letter M. Daguerre urged M. Niepce to turn his attention to this new method. M. Niepce did in fact in several instances return to the subject, and always at the request of M. Daguerre. But, these experiments of M. Niepce had always been unsuccessful; he even regretted the time which M. Daguerre had caused him to lose in a process which he

regardéd as impossible. It is true that at this period there remained to be resolved the two most important problems. The first was, to obtain the lights in the *natural state*; the second consisted in discovering the means of *fixing the images*.

These two problems M. Daguerre has since completely resolved by the application of mercury.

M. Niepce died July 5th, 1833.

On the 13th June, 1837, a definite agreement was entered into between M. Daguerre and M. Isidore Niepce, jun. as heir of M. Joseph Nicephore Niepce, by which act M. Isidore Niepce admitted that M. Daguerre had explained to him his new process. It is also specified in this deed that the process shall bear the name of M. Daguerre, he alone having been in reality the sole inventor.

These facts will appear from the following extracts of correspondence.\*

FROM M. NIEPCE, SEN. TO M. DAGUERRE.

81, Loup de Varennes, 24th June, 1831.

SIR, AND DEAR PARTNER,

I had long expected to hear from you with too much impatience not to receive and read with the greatest pleasure your letters of the 10th and 21st of *last May*. I shall confine myself in this reply to yours of the 21st, because having been engaged ever since it reached me in *your experiments on iodine*, I hasten to communicate to you the results which I have obtained. I had given my attention to similar researches previous to our connexion, but without hope of success, from the impossibility or nearly so, in my opinion, of fixing in any durable manner the images received on iodine, even supposing the difficulty surmounted, of replacing the

\* All these published letters are authenticated in the original by the signature of M. Arago, who compared them with the autographs.

lights and shadows in their natural order. My results in this respect have been entirely similar to those which the oxide of silver gave me; and promptitude of operation was the sole advantage which these two substances appeared to offer. Nevertheless, last year, after you left this, I subjected iodine to new trials, but by a different mode of application: I informed you of the results, and your answer, not at all encouraging, decided me to carry these experiments no farther. It appears that you have since viewed the question under a less desperate aspect, and I do not hesitate to reply to the *appeal* which you have made.

(Signed) I. N. NIEPCE.

---

FROM THE SAME TO THE SAME.

8th Nov. 1831.

SIR, AND DEAR PARTNER,

In terms of my letter of the 24th June, in answer to yours of the 21st May, I have completed a long series of experiments on iodine in contact with polished silver, without however attaining any result which can make me hope to succeed in deoxidizing the metal. I have fruitlessly varied my processes and combined them in numerous ways. I have not been more fortunate on that account. I now admit, once for all, the impossibility,—at least in my opinion,—of reducing to their natural state the inverted order of the lights, and also of obtaining any other than an evanescent image of objects. Besides, sir, this failure is in exact conformity with what all my former researches on metallic oxides had previously led me to expect,—a disappointment which had induced me to resolve on abandoning them. Finally, I tried iodine in contact with tinned iron; this process seemed to me at first to augur well. I remarked with surprise only,

however, in one instance while operating with this preparation in the camera, that the light acted with marked influence on the iodine, in a way so that the tints, or to speak more correctly, the lights and shadows were produced in their natural order. I know not how or why this effect took place, without my having ever again been able to produce it, though operating in exactly the same manner. But even this mode of application, as respects the permanency of the image obtained proved not less defective than the others. Thus after several other trials, I find myself just where I was, bitterly regretting, I confess it, having so long pursued a wrong path, and what is worse, so fruitlessly, &c. &c.

(Signed) I. N. NIEPCE.

---

FROM THE SAME TO THE SAME.

29th January, 1832.

SIR, AND DEAR PARTNER,

To the substances which, according to your letter, act upon silver in the same way as iodine, you may add decoction of thlaspi,\* fumes of phosphorus, and particularly of sulphur, for it is principally to their presence in these bodies that the similarity of results obtained is to be ascribed. I have remarked also that caloric produced the same effect, by the oxidizing of the metal, for from this cause proceeded in all these instances this extreme sensibility to light; but this, unfortunately, tends in no degree to the solution of the *question which engages your attention.*

For my part, I no longer employ *iodine* in my experiments, except as a means of comparing the relative quickness of their results. It is true that for the last two

\* That called Shepherd's purse.

months the weather has been so unfavourable that I have been able to do little. As to the subject of *iodine*, may I intreat you to tell me, at your earliest convenience, how you employ it? Whether it is in the solid form, or in a state of solution in a liquid?\* for in these two cases the evaporation could not certainly act in the same manner as regards promptitude of effect, &c. &c.

---

FROM THE SAME TO THE SAME.

3rd March, 1832.

MY DEAR ASSOCIATE,

Since the date of my last letter, I have confined myself, with few exceptions, to new researches in iodine, which have produced me nothing that is satisfactory, and which I resumed only because *you appeared to attach a certain importance* to them, and because, on the other hand, I should have been very happy to satisfy myself as to the application of iodine to tinned iron. But, *I repeat it*, Sir, I do not see *that we can hope to derive any advantage from this process*, more than from any other method which depends upon the use of metallic oxides, &c. &c.

(Signed) I. N. NIEPCE.

\* These expressions of M. Niepce's will, I hope, convince the most prejudiced that it was I who first pointed out iodine, not as a means of darkening certain portions of a design *already produced* by photographic processes, but as the sensitive coating upon which the image was *to be created* photogenically. The italics are in the original, in all instances.—M. DAGUERRE.



FROM M. ISIDORE NIEPCE, JUNR. TO M. DAGUERRE.

Luz, 1st November, 1837.

MY DEAR DAGUERRE,

You will doubtless, my dear friend, have been more fortunate than I, and, very probably, your portfolio is by this time enriched with the most beautiful designs! What a difference also between the method which you employ and the one by which I toil on! While I require *almost a whole day* to make one design, you—you ask only *four minutes!* What an enormous advantage! It is so great, indeed, that no person, knowing both methods, would employ the old one.

This reflection makes me feel less painfully my own want of success. For, though the old system might be described as the result of my father's labours, to the perfection of which you equally contributed, it is certain that it could not become the exclusive object of a subscription.\* Therefore, I think we should content ourselves with simply mentioning it, in order to make both methods known, for of the two yours alone will obtain the preference! &c. &c.

(Signed) ISIDORE NIEPCE.

\* At this date we were thinking of publishing the process by subscription. In the original this extract is inscribed: "Extract of a letter from M. Isidore Niepce, junr., who was endeavouring to make a collection of designs by his father's methods as perfected by M. Daguerre." The internal evidence of priority in these letters is conclusive in favour of Daguerre.

## CHAPTER III.

**Practical Description of the Daguerréotype. — Material to be employed in the Photogenic Process. — Five Steps of the Process explained. — Polishing the White Coating with Iodine. — The Camera. — Mercurial Process. — Fixing the impression, with descriptions of the Apparatus.**

THE designs are executed upon thin plates of silver, plated on copper. Although the copper serves principally to support the silver foil, the combination of the two metals tends to the perfection of the effect. The silver must be the purest that can be procured. As to the copper, its thickness ought to be sufficient to maintain the perfect smoothness and flatness of the plate, so that the images may not be distorted by the warping of the tablet; but unnecessary thickness beyond this is to be avoided on account of the weight. The thickness of the two metals united ought not to exceed that of a stout card.

The process is divided into five operations.

1. The first consists in polishing and cleaning the plate, in order to prepare it for receiving the sensitive coating, upon which the light traces the design.

2. The second is to apply this coating.

3. The third is the placing the prepared plate properly in the camera obscura to the action of light, for the purpose of receiving the image of Nature.

4. The fourth brings out this image, which at first is not visible on the plate being withdrawn from the camera obscura.

5. The fifth and last operation has for its object to remove the sensitive coating on which the design is first impressed, because this coating would continue to be affected by the rays of light, a property which would necessarily and quickly destroy the picture.

## FIRST OPERATION.

*Preparing the Plate.*

The requisites for this operation are :—

A small phial containing olive oil.

Some very finely carded cotton.

A small quantity of very fine pumice powder, ground with the utmost care, tied up in a bag of muslin sufficiently thin to allow the powder to pass through when the bag is shaken.

A phial of nitric acid diluted with water in the proportion of one pint of acid to sixteen pints of distilled water. These proportions express volume, not weight.

A frame of iron wire upon which to place the plate, in order that it may be heated by means of a spirit lamp.

Lastly, a small spirit lamp.

As already stated, these photographic delineations are executed upon silver plated on copper. The size of the plate will depend of course on the dimensions of the camera. We must begin by polishing it carefully. To accomplish this the surface of the silver is powdered all over with the pumice, by shaking the bag without touching the plate.

Next, with some cotton dipped in a little olive oil, the operator rubs the plate gently, rounding his strokes, Plate I. Fig. 2. beginning from C. During this operation, the plate must be laid flat upon several folds of paper, care being taken to renew these from time to time that the tablet be not twisted from any inequality in the support.

The pumice must be renewed and the cotton changed several times. The mortar employed for preparing the pumice must be of porphyry. The powder is afterwards finished by grinding upon polished glass with a glass muller and very pure water. And lastly, it must be perfectly dried. It will be readily apprehended of what importance it is to attend to these directions, since upon the high polish of the silver depends in a great measure the beauty of the future design. When the plate is well polished, it must next be cleaned by pow-

dering it all over once more with pumice, and rubbing with dry cotton, always rounding and crossing the strokes, for it is impossible to obtain a true surface by any other motion of the hand. A little pledget of cotton is now rolled up and moistened with the diluted acid already mentioned, by applying the cotton to the mouth of the phial and inverting it, pressing gently, so that the centre only of the cotton may be wetted and but slightly, care being taken not to allow any acid to touch the fingers. The surface of the plate is now rubbed *equally* all over with the acid applied by the pledget of cotton. Change the cotton and keep rubbing, rounding as before, that the acid may be equally spread, yet in so small a quantity as just to skim the surface so to speak. If, as frequently happens, the acid run into small drops from the high polish, change the cotton repeatedly and break down the globules as quickly as possible, but always by gently rubbing, for if allowed to rest or to run upon the plate they will leave stains. It will be seen when the acid has been properly diffused, from the appearance of a thin veil spread regularly over the whole surface of the plate. Once more powder over pumice, and clean it with fresh cotton, rubbing as before, but very slightly.

The plate is now to be subjected to a strong heat. It is placed upon the wire frame (Plate Fig. 1, both views), the silver upwards. The spirit lamp is applied below the stand, moving it round, the flame touching and playing upon the copper. This operation being continued at least five minutes, a white strong coating is formed all over the surface of the silver, if the lamp has been made to traverse with proper regularity; the lamp is now withdrawn. A fire of charcoal may be used instead of the lamp, and is perhaps preferable, the operation being sooner completed. In this latter case the wire frame is unnecessary, because the plate may be held by one corner with pincers, and so held over the fire, moving it at the same time till all is equally heated, and

the veil appear as before described. The plate is now to be cooled *suddenly*, by placing it on a cold substance, such as a mass of metal or stone, or best of all a marble table. When perfectly cold, it is to be again polished, an operation speedily performed, since the gummy appearance merely has to be removed, which is done by the dry pumice and cotton repeated several times, changing the cotton frequently. The polishing being thus completed, the operation of the acid is to be repeated three different times, dry pumice being powdered over the plate each time, and polished off very gently with the cotton, which must be very clean, care being taken not to breathe upon the plate or to touch it with the fingers, or even with the cotton upon which the fingers have rested, for the slightest stain upon the surface will be a defect in the drawing.

When the plate is not intended for immediate use, the last operation of the acid is not performed. This allows any number of plates to be kept prepared up to the last slight operation, and they may be purchased in this state if required. It is, however, indispensable that a last operation by acid as described, be performed on every plate, immediately before it be placed in the camera. Lastly, every particle of dust is removed by gently cleaning the whole edges and back also with cotton.

## SECOND OPERATION.

### *Coating the Plate.*

For this operation, we require,

The box represented, Plate II. Figs. 1 and 2.

The small board, Plate I. Fig. 3.

Four small metallic bands, the same substance as the plates.

A small handle, Plate I. Fig. 5. and a box of small tacks.

A phial of iodine.

The plate is first to be fixed upon the board by means of

the metallic bands with their small catches and tacks, as represented Plate I. Fig. 3. The iodine is now put into the little dish, D, at the bottom of the box, Plate II. Figs. 1 and 2. It is necessary to divide the iodine into pieces, in order to render the exhalation the more extensively and more equally diffused, otherwise it would form circles in the centre of the plate, which would destroy this essential requisite. The board is now fitted into its position, the plate face downwards, the whole being supported by small brackets projecting from the four corners of the box, the lid of which G is then closed. In this position the apparatus remains till the vaporization of the iodine which is condensed upon the plate, has covered its surface with a fine coating of a yellow gold colour. If this operation be protracted, the gold colour passes into violet, which must be avoided, because in this state the coating is not so sensitive to the impressions of light. On the contrary, if the coating be too pale, the image of nature in the camera will be too faint to produce a good picture. A decided gold colour—nothing more—nothing less—is the only assurance that the ground of the future picture is duly prepared. The time for this cannot be determined, because it depends upon several circumstances. Of these the two principal are the temperature of the apartment, and the state of the apparatus. The operation should be left entirely to spontaneous evaporation of the iodine—or at all events, no other heat should be used than what can be applied through the temperature of the room in which the operation takes place. It is also very important that the temperature of the inside of the box be equal to that of the air outside, for otherwise, a deposition of moisture takes place upon the plate, a circumstance most injurious to the final result. Secondly, as respects the state of the apparatus; the oftener it has been used, the less time is required, because in this case, the interior of the box being penetrated with the vapours of iodine, these arise from all sides, condensing thus

more equally and more rapidly upon the surface of the plate, a very important advantage. Hence it is of consequence to leave always a small quantity of iodine in the cup, and to protect this latter from damp. Hence, likewise, it is obvious that an apparatus of this kind which has been some time in use, is preferable to a new box, for in the former the operation is always more expeditiously performed.

Since from these causes the time cannot be fixed, *a priori*, and may vary from five minutes to half an hour, rarely more, unless the weather be too cold, means must be adopted for examining the plate from time to time. In these examinations it is important not to allow the light to fall directly upon the plate. Also, if it appear that the colour is deeper on one side of the plate than the other, to equalize the coating the board must be replaced, not exactly in its former position, but turned one quarter round at each inspection. In order to accomplish these repeated examinations without injuring the sensibility of the ground or coating, the process must be conducted in a darkened apartment into which the light is admitted side-ways, never from the roof—the door left a little ajar answers best. When the operator would inspect the plate, he raises the lid of the box, and lifting the board with both hands, turns up the plate quickly, and very little light suffices to shew him the true colour of the coating. If too pale, the plate must be instantly replaced, till it attain the proper gold tone; but if this tint be passed, the coating is useless, and the operations must be repeated from the commencement of the first.

From description this operation may perhaps seem difficult, but with a little practice one comes to know pretty nearly the precise interval necessary to produce the true tone of colour, and also to inspect the plate with great rapidity, so as not to allow time for the light to act.

When the coating has reached the proper tone of yellow, the plate with the board to which it is fixed, is slipped into

the frame (Plate III., Fig. 4.) and thus adjusted at once in the camera. In this transference care must be taken to protect the plate from the light; a taper should be used, and even with this precaution, the operation ought to be performed as quickly as possible, for a taper will leave traces of its action if continued for any length of time.

We pass now to the third operation, that of the camera. If possible the one should *immediately* succeed the other, the longest interval between the second and third ought not to exceed an hour. Beyond this space the action of the iodine and silver no longer possesses the requisite photogenic properties.

*Observanda.*—Before making use of the box, the operator should clean it thoroughly, turning it bottom upwards, in order to empty it of all the particles of iodine which may have escaped from the cup, avoiding at the same time touching the iodine with the fingers. During the operation of coating, the cup ought to be covered with a piece of gauze stretched on a ring. The gauze regulates the evaporation of the iodine, and also prevents the compression of the air on the lid being shut from scattering the particles of iodine, some of which reaching the plate, would leave large stains on the coating. For the same reason the top should always be let down with the greatest gentleness, not to raise the dust in the inside, the particles of which being changed with the vapour of the iodine, would certainly reach and damage the plate.

### THIRD OPERATION.

#### *The Camera.*

The apparatus required in this operation, is limited to the camera obscura. (Plate IV. figs. 1 & 2.)

This third operation is that in which by means of light, acting through the camera, nature impresses an image



of herself on the photographic plate, enlightened by the sun, for then the operation is more speedy. It is easy to conceive that this operation, being accomplished only through the agency of light, will be the more rapid in proportion as the objects, whose photographic images are to be delineated, stand exposed to a strong illumination, or in their own nature present bright lines and surfaces.

After having placed the camera in front of the landscape, or facing any other object of which it may be desirable to obtain a representation, the first essential is a perfect adjustment of the focus, that is to say, making your arrangements so as to obtain the outlines of the subject with great neatness. This is accomplished by advancing or withdrawing the frame of the obscured glass which receives the images of natural objects. The adjustment being made with satisfactory precision, the moveable part of the camera is fixed by the proper means, and the obscured glass being withdrawn, its place is supplied by the apparatus, with the plate attached as already described, and the whole secured by small brass screws. The light is of course all this time excluded by the inner doors; these are now opened by means of two semi-circles (see Plate) and the plate is disposed ready to receive its proper impressions. It remains only to open the aperture of the camera, and to consult a watch.

This latter is a task of some nicety, because as nothing is visible, and as it is quite impossible to determine the time necessary for producing a design, this depending entirely on the intensity of the light on the objects, the imagery of which is to be reproduced. At Paris, for example, this varies from three to thirty minutes.

It is likewise to be remarked, that the seasons, as well as the hour of the day, exert considerable influence on the celerity of the operation. The most favourable time is from seven to three o'clock; and a drawing which, in the months of June and July at Paris, may be taken in three or four

minutes, will require five or six in May or August, seven or eight in April and September, and so on in proportion to the progress of the season. These are only general data for very bright or strongly illuminated objects, for it often happens that twenty minutes are necessary in the most favourable months, when the objects are entirely in shadow.

After what has just been said, it will readily occur to the reader that it is impossible to specify with precision the exact length of time necessary to obtain photographic designs; practice is the only sure guide, and with this advantage, one soon comes to appreciate the required time very correctly. The latitude is of course a fixed element in this calculation. In the south of France, for example, and generally in all those countries in which light has great intensity, as Spain, Italy, &c., we can easily understand that these designs must be obtained with greater promptitude than in more northern regions. It is, however, very important not to exceed the time necessary, in different circumstances, for producing a design, because, in that case, the lights in the drawing will not be clear, but will be blackened by a too-prolonged solarization. If, on the contrary, the time has been too short, the sketch will be very vague, and without the proper details.

Supposing that he has failed in a first trial, by withdrawing the tablet too soon, or by leaving it too long exposed, the operator, in either case, should commence with another plate immediately; the second trial, being corrected by the first, almost insures success. It is even useful, in order to acquire experience, to make some essays of this kind.

In this stage of the process, it is the same as for the coating; we must hasten to the next operation. When the plate is withdrawn from the camera, it should immediately be subjected to the subsequent process; there ought at most not to be a longer interval than an hour between the third and fourth operations; but one is always surest of

disengaging the images when no space has been allowed to intervene.

#### FOURTH OPERATION.

##### *Mercurial or Disengaging Process.*

Here are required :

A phial of mercury, containing at least 3 oz.

A lamp with spirit of wine.

The apparatus represented in Plate V., Figs. 1, 2, and 3.

A glass funnel with a long neck.

By means of the funnel the mercury is poured into the cup *c* at the bottom of the larger vessel. The quantity must be sufficient to cover the bulb of a thermometer *F*. Afterwards, and throughout the remaining operations, no light save a taper can be used.

The board with the plate affixed is now to be withdrawn from the frame already described as adapted to the camera, and figured Pl. III., Fig. 4. The board and plate are placed within the ledges of the black iron vessel Pl. V. Fig. 1, at an angle of 45°, the tablet with sketch downwards, so that it can be seen through the glass *G*. The top *A* is then gently put down, so as not to raise up particles of the mercury.

When all things are thus disposed, the spirit lamp is lighted, and placed under the cup containing mercury. The operation of the lamp is allowed to continue till the thermometer, the bulb of which is covered by the mercury, indicates a temperature of 60° centigrade. The lamp is then immediately withdrawn; if the thermometer has risen rapidly, it will continue to rise without the aid of the lamp, but this elevation ought not to exceed 75° centigrade.

The impress of the image of Nature exists upon the plate, but it is invisible. It is not till after the lapse of several minutes that the faint tracery of objects begins to appear, of which the operator assures himself by looking through the

glass, G, by the light of a taper, using it cautiously that its rays may not fall upon, and injure the nascent images of the sketch. The operation is continued till the thermometer sink to  $45^{\circ}$  centigrade; the plate is then withdrawn, and this operation completed.

When the objects have been strongly illuminated, or when the action in the camera has been continued rather too long, it happens that this fourth operation is completed before the thermometer has fallen even to  $55^{\circ}$  centigrade. One may always know this, however, by observing the sketch through the glass.

It is necessary after each operation to clean the inside of the apparatus carefully, to remove the slight coating of mercury adhering to it. When the apparatus has to be packed for the purpose of removal, the mercury is withdrawn by the small cock E, inclining the vessel to that side.

One may now examine the sketch by a feeble light in order to be certain that the processes hitherto have succeeded. The plate is now detached from the board, and the little bands of metal which held it there are carefully cleaned with pumice and water after each experiment, a precaution rendered necessary from the coating both of iodine and mercury which they have acquired. The plate is now deposited in the grooved box (Plate II. Fig. 3.), until it undergoes the fifth and last operation. This may be deferred if not convenient; for the sketch may now be kept for months in its present state without alteration, provided it be not too frequently inspected by the full daylight.

#### FIFTH OPERATION.

##### *Fixing the Impression.*

The object of this final process is to remove from the tablet the coating of iodine, which continuing to decompose by light would otherwise speedily destroy the design when too long exposed. For this operation the requisites are—

A saturated solution of common salt, or a weak solution of hyposulphite of pure soda.

The apparatus represented Plate VI. Fig. 4. first and second views.

Two square troughs, sheet copper, Plate VI. Fig. 2. both views.

A vessel for distilled water, Plate VI. Fig. 5.

In order to remove the coating of iodine, common salt is put into a bottle with a wide mouth, which is filled one-fourth with salt and three-fourths with pure water. To dissolve the salt shake the bottle, and when the whole forms a saturated solution, filter through paper. This solution is prepared in large quantities before-hand, and kept in corked bottles.

Into one of the square troughs pour the solution, filling it to the height of an inch; into the other pour in like manner your water. The solution of salt may be replaced by one of hyposulphite of soda, which is even preferable, because it removes the iodine entirely, which the saline solution does not always accomplish, especially when the sketches have been laid aside for some time between the fourth and fifth operations. It does not require to be warmed, and a less quantity is required.

First, the plate is placed in common water, poured into a trough, plunging and withdrawing it immediately—the surface merely requiring to be moistened—then plunge it into the saline solution, which latter would act upon the drawing if not previously hardened by the washing in pure water. To assist the effect of the saline solutions, the plate is moved about in them by means of a little hoop of copper wire, Plate VI. Fig. 3. When the yellow colour has quite disappeared, the plate is lifted up with both hands, care being taken not to touch the drawing, and plunged again into the first trough of pure water.

Next, the apparatus, Plate VI. Fig. 4, two views, and the

bottle Fig. 5, having been previously prepared, made very clean, and the bottle filled with distilled water. The plate is withdrawn from the trough, and being instantly placed upon the inclined plane, Plate VI, Fig. 4, distilled water, hot but not boiling, is made to flow in a stream over its whole surface, carrying away every remaining portion of the saline wash.\*

Not less than a quart of distilled water is required when the design is of the dimensions indicated in the engraving  $8\frac{1}{2}$  by  $6\frac{1}{2}$  inches. The drops of water remaining on the plate must be removed by forcibly blowing upon it, for otherwise in drying they would leave stains on the drawing. Hence also will appear the necessity of using very pure water, for if in this last washing, the liquid contain any admixture of foreign substances, they will be deposited on the plate, leaving behind numerous and permanent stains. To be assured of the purity of the water, let a drop fall upon a piece of polished metal; evaporate by heat, and if no stain be left the water is pure. Distilled water is always sufficiently pure without this trial.

After this washing the drawing is finished, it remains only to preserve it from the dust, and from the vapours that might tarnish the silver. The mercury, by the action of which the images are rendered visible, is partially decomposed; it resists washing, by adhesion to the silver, but cannot endure the slightest rubbing.

To preserve these sketches then, place them in squares of strong pasteboard, with a glass over them, and frame the whole in wood. They are thenceforth unalterable even by the sun's light.

In travelling, the collector may preserve his sketches in a box similar to the one Plate II, Fig. 3, and for greater security may close the joints of the lid † with a collar of paper.

\* If hyposulphite has been used, the distilled water need not be so hot as when common salt has been employed.

† The author made attempts to preserve his sketches by means of

It is necessary to state that the same plate may be employed for several successive trials, provided the silver be not polished through to the copper. But it is very important after each trial to remove the mercury immediately by using the pumice powder with oil, and changing the cotton frequently during the operation. If this be neglected, the mercury finally adheres to the silver, and fine drawings cannot be obtained if this amalgam be present. They always in this case want firmness, neatness, and vigour of outline and general effect.

different varnishes obtained from succinum, copal, Indian rubber, wax, and various resins ; but he has observed, that by the application of any varnish whatsoever, the lights in these sketches were considerably weakened, and at the same time the deeper tones were hidden. To this disadvantage, was added the still greater injury from the decomposition of the mercury by all the varnishes tried ; this effect, which did not become apparent till after the lapse of two or three months, terminated in a total destruction of the forms of the objects represented. Even had this not been the case, the author would have deemed it a sufficient reason for rejecting all varnishes, that they injured the vigour and clearness of the lights. The quality most to be desired in the new art is this intensity of tone in the contrast of the lights and shadows.

## CHAPTER IV.

Dioramic Painting.—Daguerre's principal Subject.—Selection of the Canvas.—Manner of Painting.—First effect.—Second effect.—Difference between them.—Manner of introducing the Light.—The two effects illuminated by different Lights.—Remarks on Colouring.—Application.—Influence of the Sky on the Colours in Paintings—Effects of this on Artists and Connoisseurs.

THE principles of this new art have been most admired, or perhaps rather most fully developed, in the following pictures :—*The Midnight Mass*—*Land-slip in the Valley of Goldau*—*The Temple of Solomon*—and *The Cathedral of Sainté Marie de Montréal*. Each of these paintings has been exhibited with the alternate effects of night and day gradually stealing over them. To these effects of *light* were added others, arising from the decomposition of *form*, by means of which, as for example, in the *Midnight Mass*, figures appeared where the spectators had just beheld seats, altars, &c. ; or, again, as in *The Valley of Goldau*, in which rocks tumbling from the mountains replaced the prospect of a smiling valley.

## PICTORIAL PROCESSES.

The canvas is painted on both sides. In this case, therefore, whether the subjects be illuminated by reflected or refracted light, one indispensable essential is, to employ a medium or canvas which is exceedingly transparent, and the texture of which is as equal as possibly can be obtained. Either lawn or calico may be used. It is also necessary to choose those stuffs of the greatest width that is manufactured, to avoid seams, which are always difficult to conceal, especially in the principal lights of a picture.

When the canvas thus selected is stretched, it is necessary to prime it, on both sides, with at least two coats of parchment size.



*First Effect.*

The first effect, which ought to be the clearer of the two, is executed on the right side of the canvas. The sketch is first made in black-lead, taking care not to sully the canvas, the whiteness of which is the sole resource possessed by the artist for bringing out the lights of the picture; for white cannot be used in executing the first effect. The colours which I use are ground in oil, but laid upon the canvas with turpentine, to which sometimes I add a little animal oil, but only for deep shadows, and these latter may be varnished without injury. The manipulation is exactly the same as in water-colour painting, with this difference only, that the colours are prepared with oil instead of gum, and applied with turpentine instead of water. It will readily occur to the artist that he can employ neither white nor any opaque colour whatsoever by coats, which in the second effect would occasion spots more or less tinted, according to the greater or less degree of opacity. It must be the endeavour of the artist to bring out effects at a stroke—at once; going over an effect injures the transparency of the canvas.

*Second Effect.*

The second effect is painted on the wrong side of the canvas. The artist in executing this part of his work must employ no other light than that which comes from the front of the picture through the canvas. By this means the transparent forms of the first effect are seen; these forms must either be preserved, or painted over, according to the effect intended.

First of all, a wash of some transparent blue is put over the whole canvas. This coating, like the other colours, is prepared in oil, and laid on in essence of turpentine. The marks of the brush are effaced by a huge tool of badger's skin.

By means of this coating the seams also are concealed to a certain extent, by taking care to lay it on thin along the selvages, which have always less transparency than the rest of the canvas. When this coating is dry, the alterations intended to be made on the first effect, are sketched out.

In executing this second effect, the artist has nothing to do beyond modelling in light and shadow, without reference to local colour or to the colours of the first picture, which are seen by transmitted light as transparencies. This part is executed by means of a tint of which white is the base, with which lamp-black is mixed in order to obtain a grey, the strength of which is ascertained by applying it to the wash of blue on the wrong side, and then viewing it from the right side of the picture, from which position it will not be at all perceptible if of the proper strength. The gradation of tones is produced by the greater or less opacity in this tint. It may happen that the shadows of the first effect interfere with the execution of the second. To remedy this inconvenience, and to conceal these shadows, we can harmonize their force, by using the gray of a corresponding opacity according to the strength of the shadows which it is the intention to destroy.

It will occur to the artist, that it is necessary to urge this second effect to its utmost power.

When this general effect of light and shadow is finished on these principles, and the desired effect obtained, the picture may be coloured, the artist using only the most transparent tints prepared in oil. It is still a water colour that is to be executed; but less turpentine must be used in these glazings, which produce a powerful effect only in proportion as they are repeated several times, and with more of oil than essence. However, for slight effects of colour, turpentine is sufficient.

#### THE ECLAIRAGE OR LIGHTING UP THE PICTURES.

The first effect painted on the right or front of the canvas is

lighted by reflection, that is to say, only by a light which comes from the front, while the second effect—that painted on the wrong side receives its light by refraction; that is, from behind only. In both effects we may employ both lights at once, in order to modify certain portions of the picture.

The light which gives effect to the painting in front should come from above. The illumination which falls upon the second effect—that painted behind, should come from vertical openings, it being always understood that these are to be completely closed when the first effect only is to be seen.

If it happen to be necessary to modify a part in the first effect or picture by a light belonging to the second, that is, coming from behind, then this light must be inclosed so as not to fall, except on the proper place. The windows or openings ought to be distant from the paintings at least two metres,\* in order to give a power of modifying the light by transmitting it through coloured media, as the exigencies of desired effects may demand. The same means are requisite for the first effect or front picture.

It is admitted that the colours which appear on objects generally are produced only by the arrangement of the molecules of these objects. Consequently all those substances used in painting are colourless: they only possess the power of reflecting such or such a ray of light which in itself contains all the colours. The more pure these substances are, the more decidedly do they reflect the simple colours; never, however, by an absolute or independent property, which by the way, it is not necessary they should do in order to represent the effects of nature.

To explain then the principles upon which Dioramic paintings are executed and lighted up, take as an example the effect produced when light is decomposed; that is to say, when a portion of its component rays is intercepted.

Put upon a canvas two colours—the brightest possible—the one red, the other green, both as near as may be of the

\* Between 7 and 8 feet English.

same intensity. Now, interpose a red medium, as a coloured glass, in the stream of light which falls upon them—what happens? The red colour reflects the rays which belong to it; the green remains black. Reverse the experiment by interposing a green glass—the effect also is reversed; the green colour gives forth its proper reflection; the red is now black. The effects, indeed, are not perfect unless the interposed media completely exclude all rays but their own, a condition not easily obtained, for coloured media have rarely the power of excluding all but one ray. The general effect, however, is sufficiently determined.

To apply this principle to dioramic paintings, though in these paintings there are only two effects represented, one of day in front, one of night behind. These effects not passing the one unto the other without a complicated combination of the media which the light had to traverse, produce an infinity of other effects similar to those which nature presents in her transitions from morning to night, and the reverse. It must not be imagined that it is necessary to employ media of very intense hues in order to obtain striking modifications of colour, for often a slight shade in the medium suffices to operate a very great change in the effect.

It will be understood from these principles of dioramic art in which striking results are obtained by a single decomposition of light, how important it is to observe the aspect of the sky when we would appreciate the tone of a picture, whose colouring matters are thus subject to decompositions so great. The best light for this purpose, is that from a pale sky; for where the sky is blue, it is the blue tone of the picture also, and consequently its cold tone which comes out most powerfully, while its warm tones remain inactive. Their media are not present, and they are cast comparatively back into neutral tints by the blue medium of the sky—so favourable to the cold tones of the picture. It happens, on the contrary, when the sky is coloured, that the warm tones of the picture

—its reds and yellows—come forth too vigorously, and, overpowering its colder tones, injure its harmony, or, it may be, give it quite a different character—a warm instead of a cold tone of colour.

It is easy to understand from these observations that the uniform intensity of colours cannot be maintained from morning to evening. We may even venture to assert it to be physically demonstrated that a picture cannot be the same at all hours of the day. This, perhaps, is one of the causes which contribute to render good painting so difficult to execute, and so difficult to appreciate. Painters, led into error by the changes which take place between morning and evening in the appearance of their pictures, falsely attribute these alterations to a variation in their manner of seeing, and colour falsely, while, in reality, the change is in the medium—in the light.

## NOTES.

---

(1) M. Daguerre is a professional man, member of the French Academy of Fine Arts, of the Academy of St. Luke, &c. His works as an artist are of great excellence, and from these his reputation among his countrymen stood high long before the photographic discoveries gave him a European fame. He is a man of extreme modesty and great personal worth. On the 19th August, when the secret of the process was to be for the first time publicly announced in the Institut, M. Arago began his admirable address on this occasion by apologizing for his taking apparently the place of another: "I have to express my regret that the inventor of this most ingenious apparatus has not himself undertaken to explain all its properties. This morning even I begged—I intreated the able artist to yield to a wish which I well knew is universal; but a bad sore throat—fear of not being able to render himself intelligible without the aid of plates—in short," added the philosopher, with admirable feeling, "a little too much modesty—a burthen that the world bears so lightly—proved obstacles which I have not been fortunate enough to surmount. I hope, then, I shall be pardoned the appearance which I am this day proud to make before this assembly." M. Arago's explanations were delivered without notes; his eloquence, so admirably adapted to the subject, could only be exceeded by the *reverential attention* with which his explanations were heard by probably the largest meeting that had ever assembled in the halls of the Institut. M. Daguerre is ardently devoted to his profession; and, on looking at some of his pictures, it is hardly possible not to believe that he has taken lessons from his own secret, in a most skilful management of the lights which they exhibit. A pleasing proof of his simple love of art appears in his title-page, which thus announces the author—"by Daguerre, Painter," &c.

(2) The agreement between the Government and the discoverers of Photography, runs in these terms:—

Between the undersigned, M. Duchatel, Secretary of State for the Home Department, on the one part; and

MM. Daguerre (Louis Jacques Maude) and Niepce, junr. (Joseph Isidore), on the other;

It has been agreed—as follows :

Art. 1.—MM. Daguerre and Niepce, junr. make over to the Minister for the Home Department, acting for the State, the process of M. Niepce, senr., with its improvements by M. Daguerre, and also of the last process of M. Daguerre for fixing the images of the camera obscura. They bind themselves to place in the hands of the Minister for the Home Department a sealed packet, containing the history and description, exact and complete, of the said processes.

Art. 2.—M. Arago, Member of the Chamber of Deputies and of the Academy of Sciences, who has already knowledge of the said processes, shall verify previously all the writings in said deposit, and shall certify their correctness.

Art. 3.—The deposit shall not be opened, nor the description of the processes given to the public, till after the adoption of the bill already mentioned ; then M. Daguerre shall, if required, operate in presence of a Commission named by the Secretary for the Home Department.

Art. 4.—M. Daguerre makes over, in addition, and engages to give, in like manner, information in the processes of painting and optic which distinguish his invention of the Diorama.

Art. 5.—He shall be held bound to publish all the improvements which from time to time he may make in each and all of these inventions.

As the price of these rights given up, the Minister for the Home Department engages to demand from the Chambers, for M. Daguerre, who accepts an annual pension for life of six thousand francs.

For M. Niepce, who likewise accepts an annual pension for life of four thousand francs.

Art. 7.—In case the Chambers should not pass, during the present Session, the Bill granting these pensions, the present agreement shall become null and void, and MM. Daguerre and Niepce shall be returned their communication unopened.

Art. 8.—The present agreement shall be registered on payment of one franc.

Made triple, at Paris, 14th June, 1839.

Signed by the contracting parties, &c.

Fig. 1

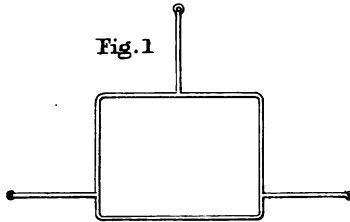

Fig 1. 2<sup>nd</sup> view.

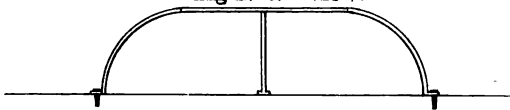

Fig. 2.

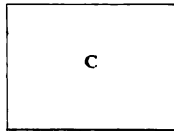

Fig 2. 2<sup>nd</sup> view

Fig 3.

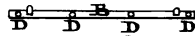
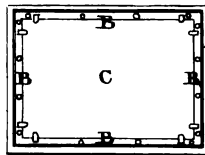

Fig 3. 2<sup>nd</sup> view.

Fig 4.



Fig. 6

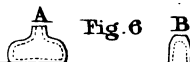
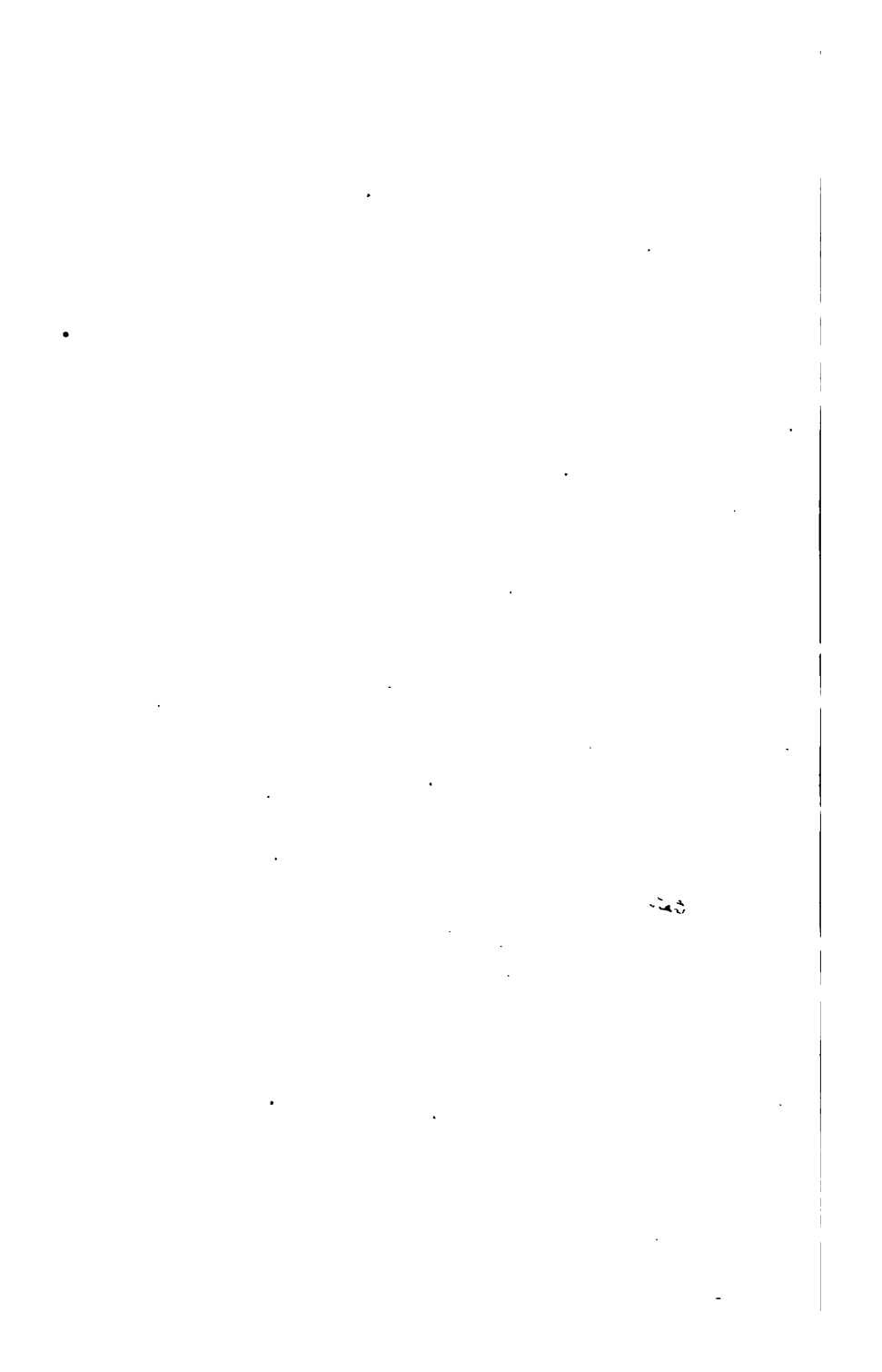

Fig. 5







Pl. II

Line AB.

B

Metre

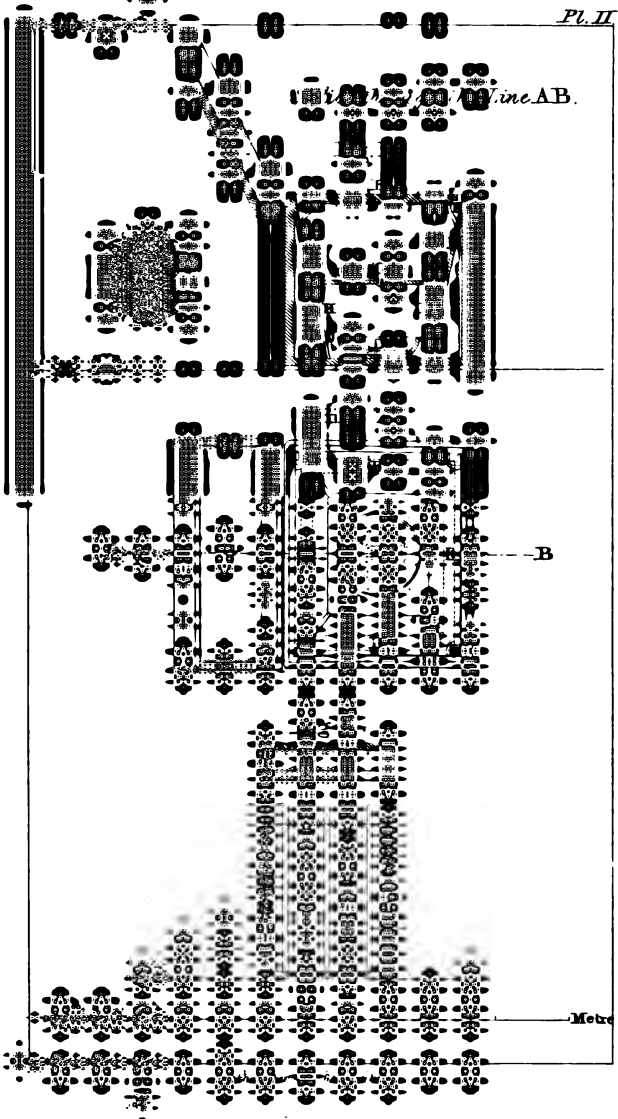

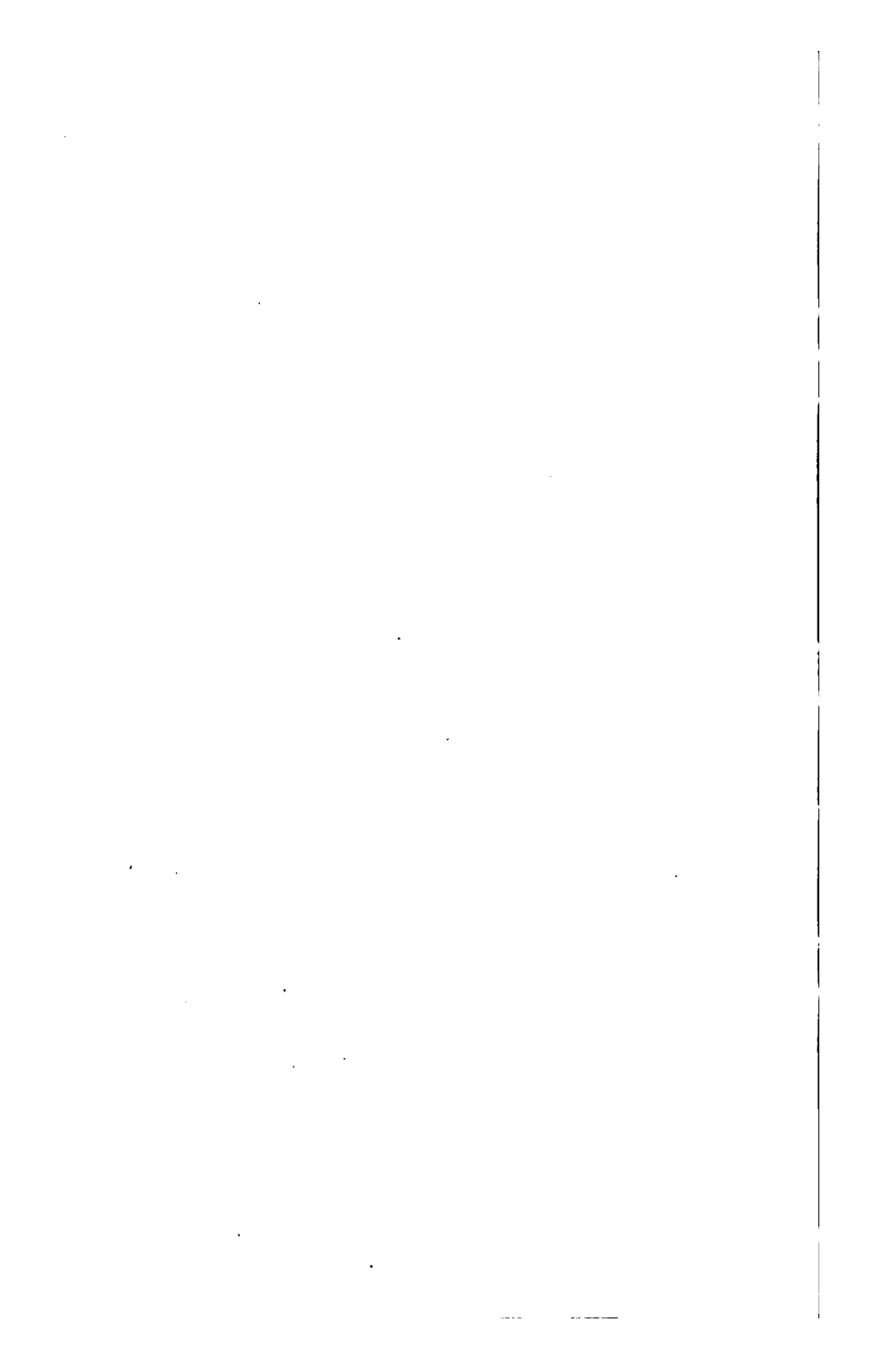

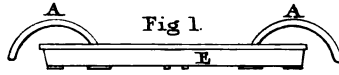

Fig 1.

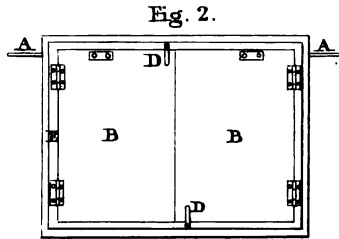

Fig. 2.

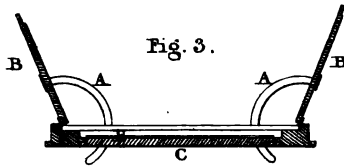

Fig. 3.

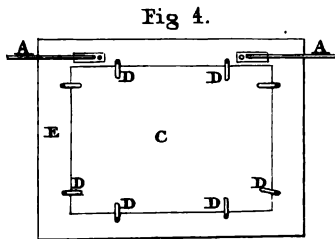

Fig 4.

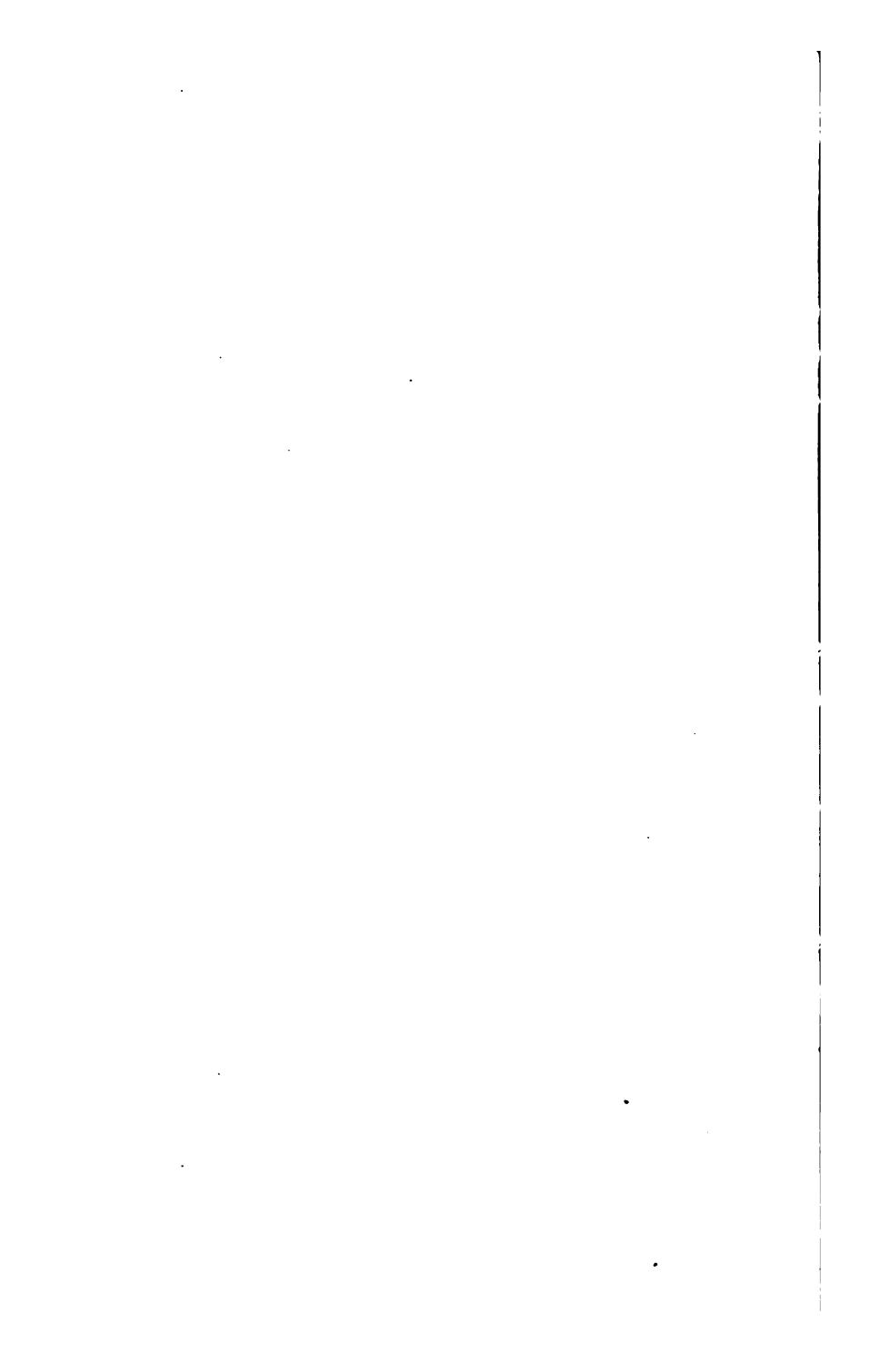

Fig. 1.

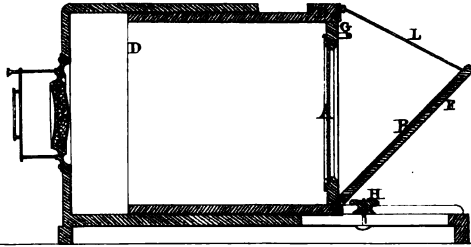
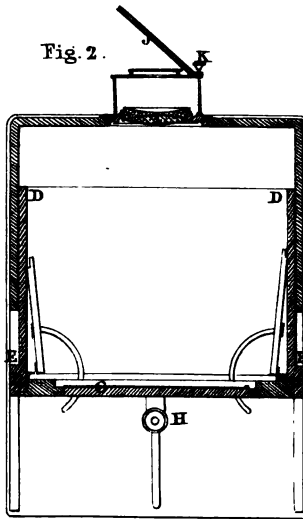
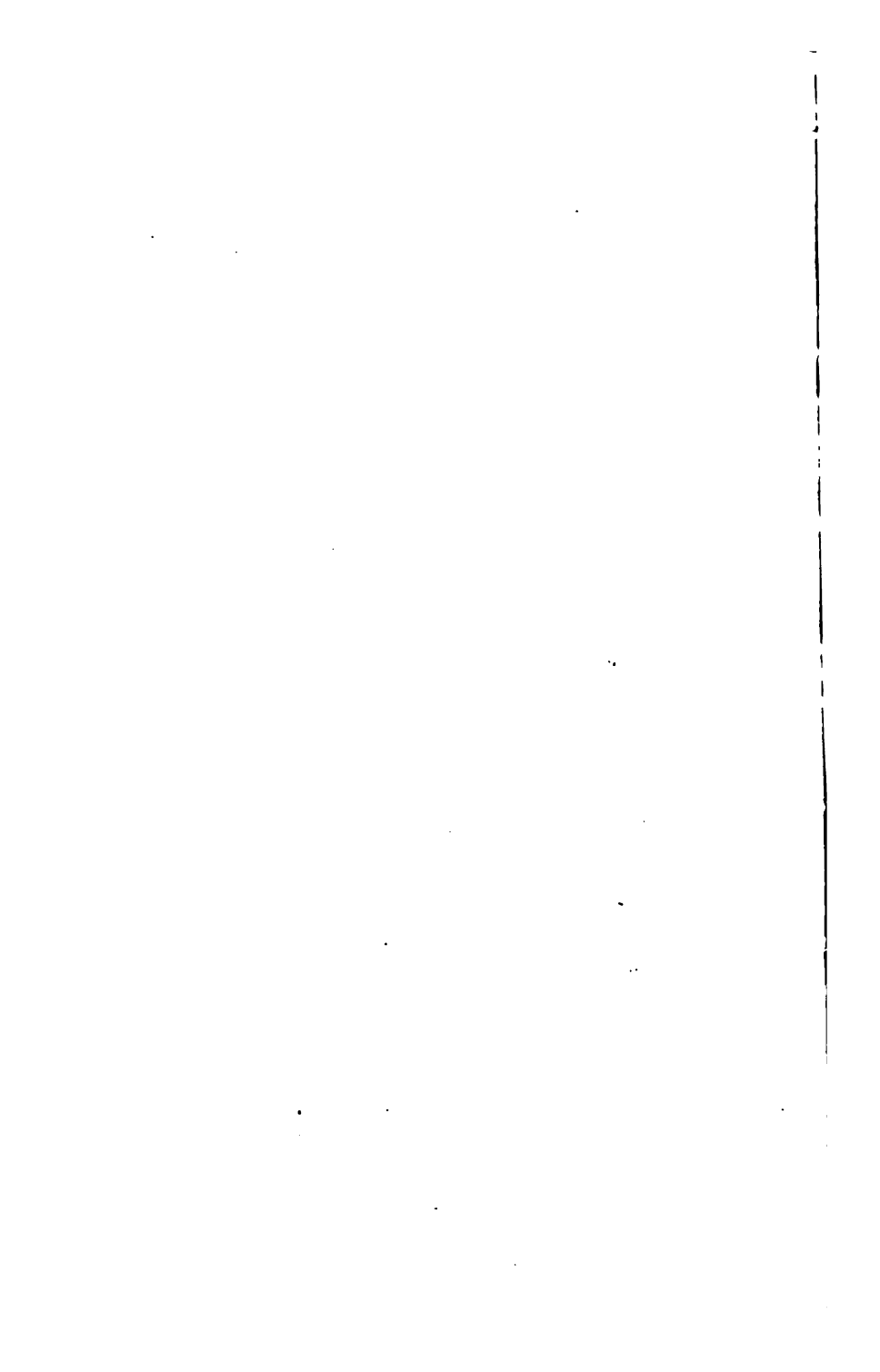

Fig. 2.





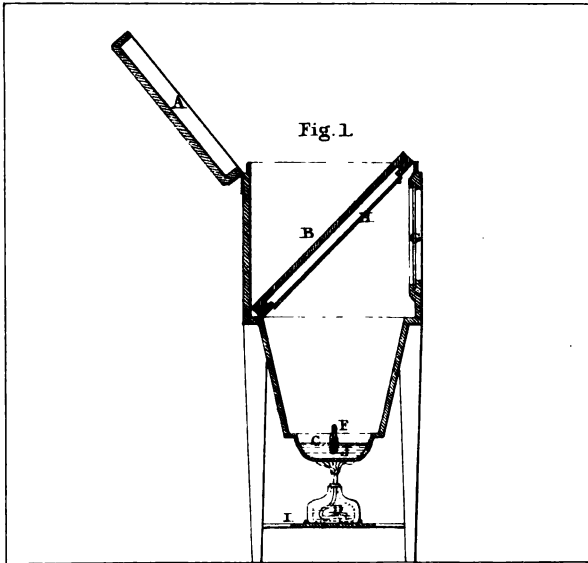

Fig. 2.

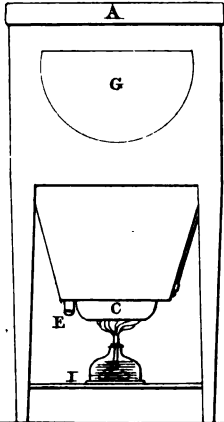

Fig. 3.

